

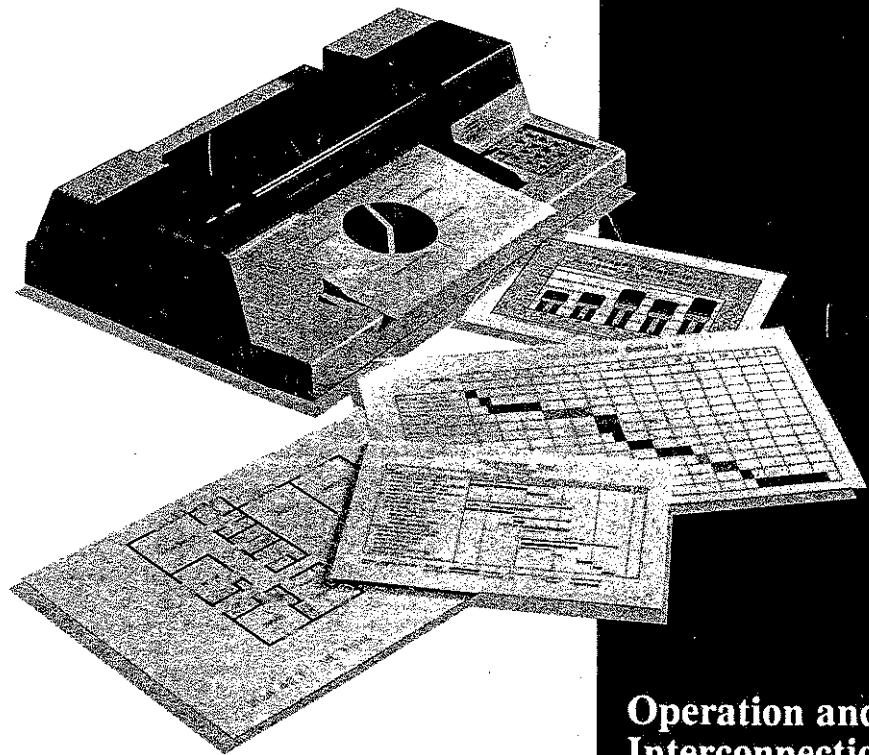

HP 7475A
Graphics Plotter



**Operation and
Interconnection
Manual**

Limited Warranty

One-Year Limited Hardware Warranty

Except when used as part of an HP system, Hewlett-Packard warrants your graphics peripheral hardware product against defects in materials and workmanship for a period of one year from receipt by the end user. If HP perceives notice of such defects during the warranty period, HP will either, at its option, repair or replace products which prove to be defective.

Should HP be unable to repair or replace the product within a reasonable amount of time, customers' alternative exclusive remedy shall be a refund of the purchase price upon return of the product.

If this product was purchased as part of an HP system in a coordinated shipment or as a system add-on, it is warranted against defects in material and workmanship during the same period as the HP system.

Exclusions

The above warranty shall not apply to defects resulting from: improper or inadequate maintenance by customer; customer-supplied software or interfacing; unauthorized modification or misuse; operation outside of the environmental specifications for the product; or improper site preparation and maintenance.

Obtaining Warranty Service

To obtain warranty service, products must be returned to a service facility designated by HP. HP may repair on-site at the option of the customer. Customer is responsible for travel charges when on-site repair is requested.

Warranty service for products purchased as part of a system will be subject to service in accordance with the system support services.

Customer shall prepay shipping charges for products returned to HP for warranty service and HP shall pay for return of the products to customer. However, customer shall pay all shipping charges, duties, and taxes for products returned to HP from another country.

Warranty Limitations

HP makes no other warranty, either expressed or implied, with respect to this product. HP specifically disclaims the implied warranties of merchantability and fitness for a particular purpose. Some states or provinces do not allow limitations on the duration of an implied warranty, so the above limitation or exclusion may not apply to you. However, any implied warranty of merchantability or fitness is limited to the one-year duration of this written warranty.

This warranty gives you specific legal rights, and you may also have other rights which may vary from state to state, or province to province.

Exclusive Remedies

The remedies provided herein are customer's sole and exclusive remedies. In no event shall HP be liable for any direct, indirect, special, incidental, or consequential damages, whether based on contract, tort, or any other legal theory. Some states or provinces do not allow the exclusion or limitation of incidental or consequential damages, so the above limitation or exclusion may not apply to you.

Obtaining Service During or After Warranty

During the Warranty Period

If your hardware should fail during the warranty period, follow the test procedures in the system manuals, then bring the failed piece of equipment to an Authorized HP Personal Computer Dealer Repair Center — or send the equipment to one of the HP Field Repair Centers listed in the directory sent with your product. (HP may repair on-site at your option, in which case you are responsible for travel charges).

After the Warranty Period

If your hardware should fail after the warranty period, follow the test procedures in the system manuals, then contact an Authorized HP Personal Computer Dealer Repair Center or call your HP Sales and Service Office for details of the services available.

If you are uncertain about which unit to return, call your Authorized HP Personal Computer Dealer or a Field Repair Center for assistance.

When sending equipment to a Field Repair Center, please follow the procedures in the "Shipment" section of your operator's manual.

Getting Help

Hewlett-Packard has support services available to help you in case you have a problem with your HP 7475A graphics plotter. Following are suggestions of places to turn for this support.

Before you call for customer support, make sure you do the following.

1. Review the *I've Done Everthing You've Said and It Still Doesn't Work . . .* section of Chapter 3 in this Operation and Interconnection Manual.
2. Perform the built-in *Demonstration Plot/Confidence Test* in Chapter 1.
3. Make sure you are using the correct interface cable and dip switch settings, as explained in Chapter 3 and Appendix A.
4. Check with your software vendor for help.

Your Dealer

If you still have difficulty, begin by contacting the person from whom you purchased your HP 7475A graphics plotter. Your sales representative is familiar with your needs, equipment and software and should be able to provide you with the information you want.

HP 7475A Graphics Plotter Customer Assist

If you don't get the answer to your questions from your dealer or sales representative, Hewlett-Packard has an HP 7475A Graphics Plotter Customer Assist service available to you. The HP 7475A Assist staff can provide you with help by answering questions on topics such as setting up your plotter and computer, and can help you find third party software solutions for your special plotting needs.

When you call the HP 7475A Assist group, please have the following information available to help us answer your questions more quickly.

- Identify what computer you are using. _____

- Identify any special equipment or software you are using (for example, spoolers, networks, switchboxes, modems or special software drivers). _____

- Identify what cable you are using (by part number) and where you purchased it. _____

- Identify the type of interface option on your plotter (RS-232-C or HP-IB). _____

- Identify the software name and version you are currently using. _____

The HP 7475A Assist service is available from 7 am - 4 pm (Mountain Standard Time), Monday through Friday.

(208) 323-2551

Should the plotter require service, please refer to the last section in Chapter 1 for shipping instructions.

Table of Contents

Chapter 1: Owner's Information	1-1
Introduction	1-1
Understanding Manual Conventions	1-2
Initial Inspection and Accessories Inventory	1-2
Accessories Supplied	1-3
Accessories Available	1-3
Input Power Requirements	1-4
Power Options	1-4
Line Voltage Selection	1-4
Fuse Protection	1-5
Grounding Requirements	1-5
Power Cord	1-5
Operator Maintenance	1-7
General Cleaning	1-7
Pen Carousel Cleaning	1-8
Shipment	1-8
Chapter 2: Plotter Operation	2-1
Introduction	2-1
Major Feature Locations	2-1
Introduction to Programming Languages	2-2
What Is a Program?	2-2
What Programming Languages Do I Use?	2-3
AGL (A Graphics Language)	2-3
HP-GL (Hewlett-Packard Graphics Language)	2-3
Introduction to the Plotter Coordinate System	2-4
Coordinate System Orientation	2-5
Hard-Clip Limits	2-5
The Scaling Points P1 and P2	2-7
HP-GL Scaling	2-7
AGL Scaling	2-8
Setting the Scaling Points	2-9
Preparing Equal-Sized Plots	2-9
Squeezing the Scaling Area	2-10
Rotating the Coordinate System	2-12
Controls and Indicators and Their Functions	2-14
Front Panel	2-16
Rear Panel	2-20

Table of Contents (Continued)

Chapter 2: Plotter Operation (Continued)	
Option 001 (RS-232-C/CCITT V.24)	2-21
Option 002 (HP-IB)	2-23
Setting Up the Plotter	2-24
Choosing the Correct Pen and Medium	2-25
Loading Pens and the Carousel	2-25
Loading the Plotting Medium	2-26
Turning On the Power	2-28
The Demonstration Plot/Confidence Test	2-31
Chapter 3: Plotter Interconnection	3-1
Introduction	3-1
If Your Computer Isn't Listed	3-1
If Your System Configuration Is Different From the One Listed	3-2
If the Interconnection Doesn't Work	3-2
If You Are Using a Graphics Software Package	3-3
Personal Computers (Compatibles using RS-232-C Interface) ...	3-4
(AT&T PC 6300 COMPAQ* DESKPRO* 286 and 386/20 HP Vectra, ES/12, QS/16, and RS/20 IBM* AT, PC, PC/XT, and PS/2)	
Interconnection Instructions	3-4
Testing Communication without BASIC	3-5
Testing Communication with BASIC	3-6
Apple* IIe or II Plus Computer (RS-232-C Interface)	3-7
Interconnection Instructions	3-7
Running the Test Program	3-9
Apple IIe or II Plus Computer (HP-IB Interface)	3-10
Interconnection Instructions	3-10
Running the Test Program	3-11
Apple /// Computer (RS-232-C Interface)	3-13
Interconnection Instructions	3-12
Running the Test Program	3-14

*COMPAQ is a registered trademark of Compaq Computer Corporation.

*DESKPRO is a registered trademark of Compaq Computer Corporation.

*IBM is a registered trademark of International Business Machines Corporation.

*Apple is a registered trademark of Apple Computer, Inc.

Table of Contents (Continued)

Chapter 3: Plotter Interconnection (Continued)

Apple Macintosh*/Macintosh Plus/II/SE	
(RS-232-C Interface)	3-15
Interconnection Instructions	3-15
Testing Communication with BASIC	3-16
Commodore Amiga* Personal Computers (Serial Interface)	3-17
Interconnection Instructions	3-17
Verifying Communication	3-19
HP Series 200 Personal Technical Computer	
(HP-IB Interface)	3-20
Interconnection Instructions	3-20
Running the Test Program	3-21
HP Touchscreen Personal Computer (HP 150)	
(RS-232-C Interface)	3-22
Interconnection Instructions	3-22
Running the Test Program	3-24
HP Touchscreen Personal Computer (HP 150)	
(HP-IB Interface)	3-25
Interconnection Instructions	3-25
Running the Test Program	3-26
Chapter 4: Selecting Media, Pens, and Ink	4-1
What Kind of Output Do You Need?	4-1
Understanding Media	4-2
Chart Paper	4-2
Glossy Presentation Paper	4-2
Overhead Transparency Film	4-3
Double-Matte Polyester Film	4-3
Understanding Pens and Inks	4-3
Fiber-Tip Pens	4-4
Drafting Pens	4-4
Combining Pens and Media	4-7
Purchasing Supplies	4-8
Appendix A: RS-232-C/CCITT V.24 Interface	
Information	A-1
RS-232-C Pin Allocations	A-1
RS-232-C Cable Schematics	A-2

*Macintosh is a registered trademark of Apple Computer, Inc.

*Amiga is a registered trademark of Commodore-Amiga, Inc.

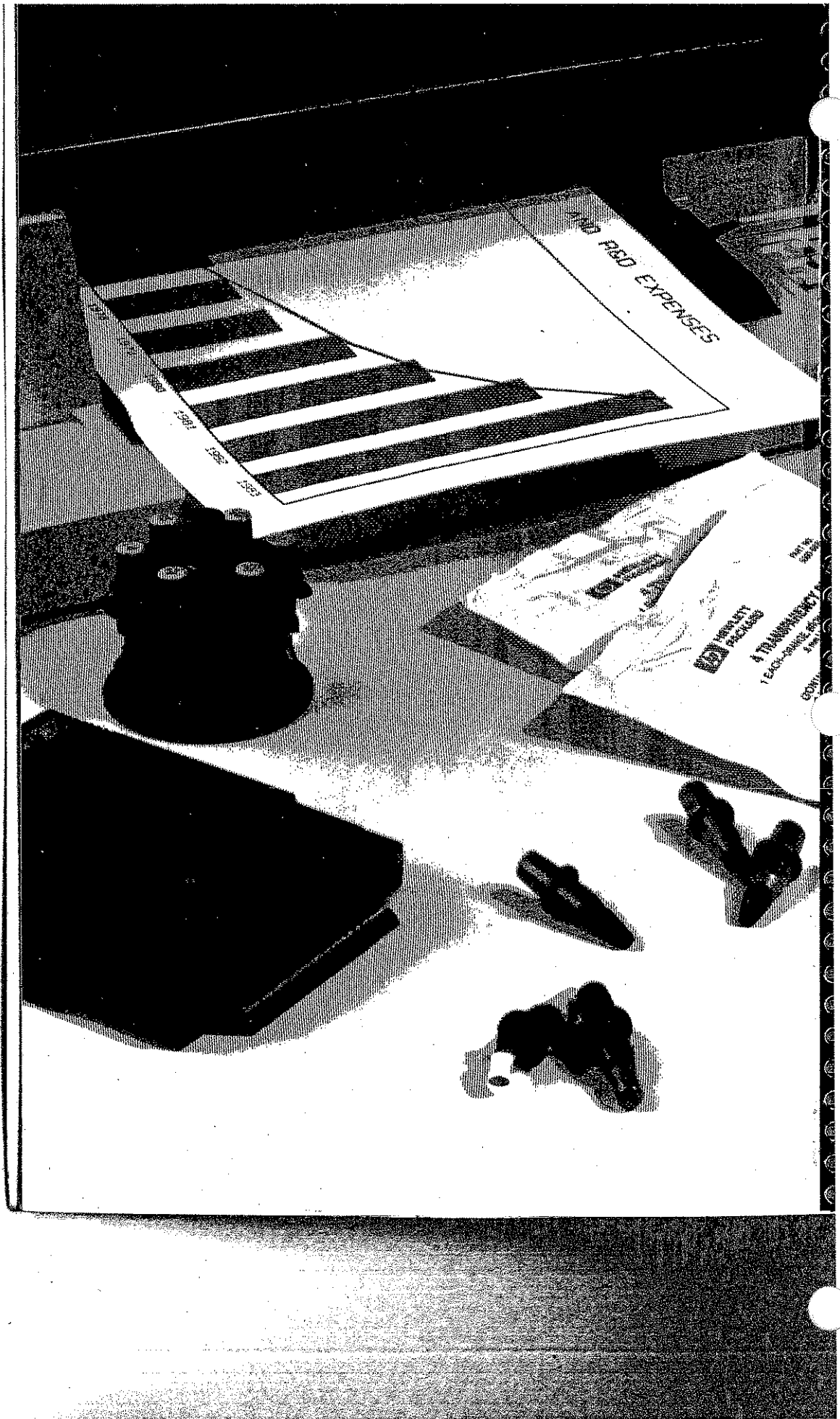

Chapter 1

Owner's Information

Introduction

This manual contains general information to familiarize you with the capabilities and operation of the HP 7475A Option 001 and Option 002 Graphics Plotters. The Option 001 plotter is equipped with the RS-232-C/CCITT V.24 Interface. The Option 002 plotter is equipped with the Hewlett-Packard Interface Bus (HP-IB), which conforms to ANSI/IEEE 488-1978 specifications. Both interface options use the Hewlett-Packard Graphics Language (HP-GL) for control of plotter graphics capabilities. Unless specifically noted, all information in this manual pertains to both interface options.

NOTE: All information in this manual for the RS-232-C interface applies equally to the CCITT V.24 interface. For purposes of simplicity, both are referred to as RS-232-C. ■

This manual is designed to show you how to operate, but not program, the plotter. The information given will enable you to verify that your plotter has not been damaged in shipment and that it is compatible with the power available in your geographic area. It explains each control and indicator, the plotter's coordinate system, and how to set up the plotter and run the built-in demonstration plot.

Additional information is given to show you how to connect the plotter with many commonly used computers.

All plotters are shipped with this manual and a Reference Card (Part No. 07475-90004). The Reference Card contains a summary of HP-GL and device control instructions, plotter default conditions, and a list of error numbers and their meanings. The plotter is supported on a number of HP computer systems using higher level graphics support than HP-GL. In most cases, high level graphics support is available through graphics programming ROMs or software, each of which is supported with a comprehensive user's manual which will answer most of your questions related to programming. Contact your HP sales representative or dealer regarding high level graphics support available with your HP computer.

Understanding Manual Conventions

Before reading this manual, you should understand the meaning of type styles and number representation used in text. Words typed in small, **boldface** type are either buttons, switches, or words actually found on the plotter. Numbers are shown using SI (International System of Units) standards. Numbers with more than four digits are placed in groups of three, separated by a space instead of commas, counting both to the left and right of the decimal point (54 321.123 45).

Initial Inspection and Accessories Inventory

The individual parts of your plotter were thoroughly inspected before the unit was shipped to you, and the instrument should be in good operating order. Carefully inspect the plotter and accessories for any physical damage sustained in transit. Notify the nearest HP Sales and Support Office or authorized HP dealer and file a claim with the carrier if the unit is received in a damaged condition.

Please check to ensure that you have received all of the items that should accompany the plotter. Refer to the table of Accessories Supplied and check that all accessories are present. If you have any difficulties with the plotter, if it is not operating properly, or if accessories are missing, contact the nearest HP Sales and Support Office or authorized HP dealer.

Retain the original packing materials and carton. If the plotter must be shipped, this will save having to order new packing materials and a carton from HP.

Accessories Supplied

The following items are supplied with each 7475A plotter:

Item	Quantity	Part Number
Operation and Interconnection Manual	1	07475-90002
Reference Card	1	07475-90004
Customer Survey Card	1	5958-2664
HP Field Repair Centers	1	5957-2658
HP Sales and Support Offices	1	5955-7441
Power cord (appropriate cord supplied, based on origin of sales order)	1	—
Fiber-tip carousel	1	5061-5080
Assorted pen and media samples		

Owner's Information

Accessories Available

The following items are available and can be purchased using the appropriate part number. For information on available pen and media supplies, refer to the *Supplies and Cables* brochure shipped with your plotter.

Item	Part Number
Service Manual	07475-90000
Interfacing and Programming Manual	07475-90001
Carrying case (not suitable for shipping plotter)	07475-60001
Transit case (suitable for shipping plotter)	1540-0861
Dust cover	07475-60010
Standard digitizing sight	09872-60066
Slanted digitizing sight	07585-60191
Special Y-cable (used to connect an option 001 plotter between a terminal and computer)	17455A
Interface cable for IBM personal computer	17255D
Male-to-male RS-232-C Standard Cable	17355M
Male-to-male RS-232-C Modem Eliminator Type Cable	13242G or 17255M
Pen organizer (a smoked plastic container for storing 20 fiber-tip pens)	92177V
Grit wheel brush	8710-1386
Drafting pen carousel	07470-60030
Replacement boots for drafting pen carousel (2)	07475-60038

Input Power Requirements

WARNING

To prevent operator injury or damage to the plotter, verify that the line voltage setting and fuse protection are correct **BEFORE** connecting the line power. Also ensure the line power cord is connected to a line power outlet that is provided with a protective earth ground contact.

Power Options

The 7475A can be configured to operate with any of the following power sources:

Line Voltage:	100 V ~ +5%, -10%
	120 V ~ +5%, -10%
	220 V ~ +5%, -10%
	240 V ~ +5%, -10%
Line Frequency:	48 to 66 Hz, single phase
Maximum Line Current:	480 mA @ 100 V
	400 mA @ 120 V
	220 mA @ 220 V
	200 mA @ 240 V
Consumption:	35 Watts maximum

Line Voltage Selection

The 7475A is shipped from the factory with the line voltage set to the nominal value for the area specified as the shipment's destination. The voltage selected for the plotter is identified in the recessed window on the rear panel. Refer to the Major Feature Locations photograph in Chapter 2. The line voltage can be changed by qualified service personnel only. Line voltage selection procedures are contained in the 7475A Service Manual.

Fuse Protection

WARNING

To avoid the possibility of injury, disconnect the ac power cord before installing or replacing a fuse.

The 7475A is factory equipped with a fuse appropriate to the factory-set line voltage. The selected line voltage and the corresponding fuse rating is shown in the recessed window on the rear panel. To change or inspect the line fuse, turn the fuse holder on the rear panel in the direction of the arrow (counterclockwise) until the fuse holder releases. Remove the fuse holder and insert a slo-blo type T fuse which corresponds with the voltage setting. Fuse ratings for each voltage setting are shown below. Place the fuse holder back into the plotter, and turn the fuse holder clockwise, while pressing in, until the lock engages and the fuse remains flush with its casing.

Voltage	U.S. Fuse	European Fuse
100 V or 120 V	0.6AT(SB)/125 V	—
220 V or 240 V	0.3AT(SB)/250 V	0.315/AT(SB)/250 V





NOTE: Fuses and fuse caps appropriate to the plotter shipment destination are installed at the factory. U.S. fuses are $\frac{1}{4} \times 1\frac{1}{4}$ inches and use HP 2110-0565 fuse caps. European fuses are 5×20 millimetres and use HP 2110-0567 fuse caps. ■

Grounding Requirements

To protect operating personnel, the plotter must be properly grounded. The plotter is equipped with a three-conductor power cable which, when connected to an appropriate power outlet, grounds the plotter. To preserve this protection feature, do not operate the plotter from a line power outlet which has no ground connection.

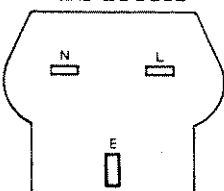
Power Cord

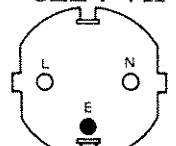
Power cords with different plugs are available for the plotter. The cord packaged with each plotter depends upon its destination. The power cords supplied by HP have a standard female plug which mates with the power-input socket in the plotter. The polarities of the male plugs shown in the accompanying chart are matched to the line power outlets used in the indicated areas. If the plotter has the wrong power cord for the area, please contact your local HP Sales and Support Office or authorized HP dealer.

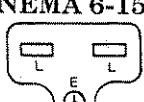
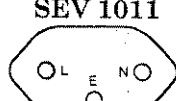
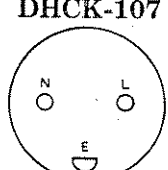
<p>BS 1363A</p> 	<p>HP Part Number 8120-1351; 250 V, 13 A, 1 ϕ plug rating. For use in United Kingdom.</p>	<p>900</p>
<p>AS C112</p> 	<p>HP Part Number 8120-1369; 250 V, 10 A, 1 ϕ plug rating. For use in Australia, New Zealand.</p>	<p>901</p>
<p>CEE 7-VII</p> 	<p>HP Part Number 8120-1689; 250 V, 10/16 A, 1 ϕ plug rating. For use in East and West Europe, Saudi Arabia, Egypt.</p>	<p>902</p>
<p>NEMA 5-15P</p> 	<p>HP Part Number 8120-1378; 125 V, 15 A, 1 ϕ plug rating. For use in Canada, Japan, Mexico, Philippines, Taiwan, UL approved in United States.</p>	<p>903</p>
<p>NEMA 6-15P</p> 	<p>HP Part Number 8120-0698; 250 V, 15 A, 1 ϕ plug rating. UL approved in United States.</p>	<p>904</p>
<p>SEV 1011</p> 	<p>HP Part Number 8120-2104; 250 V, 10 A, 1 ϕ plug rating. For use in Switzerland.</p>	<p>906</p>
<p>DHCK-107</p> 	<p>HP Part Number 8120-2956; 250 V, 10 A, 1 ϕ plug rating. For use in Denmark.</p>	<p>912</p>

NOTE: All plugs are viewed from connector end.

L = Line or Active Conductor (also called "live" or "hot")
 N = Neutral or Identified Conductor
 E = Earth or Safety Ground

Power Cord Configurations

Operator Maintenance

There are no operator-serviceable parts inside the HP 7475A plotter. Maintenance which can be performed by the operator is limited to maintaining the appearance of the plotter. All other maintenance must be performed by qualified service personnel. Refer to the Shipment paragraph for instructions on how to obtain servicing assistance.

General Cleaning

WARNING

Disconnect the plotter from the power source prior to performing any maintenance. **DO NOT** allow water to run onto electrical components and circuits or through openings in the enclosure as this may create a shock hazard.

CAUTION

Do not attempt to clean the grit wheels. Cleaning solutions may dissolve the adhesive which secures the grit particles to the wheels.

Thorough cleaning should be performed periodically. Cleaning intervals are determined by the type of operation, local air contamination, and climatic conditions. Cleaning procedures should include the following:

1. Blow away dust accumulation in the grit wheel area, with compressed air, if available, or brush away dust using the grit wheel brush (Part No. 8710-1386).
2. Clean the outer surface of the plotter with a damp sponge or cloth. Use a mild cleaning solution if necessary, followed by water to rinse off any residue. Wipe dry after cleaning.

NOTE: To prevent scratching, do not use abrasive cleaners on the plastic carriage cover or on the outer surface of the plotter. In addition, some "mild" detergents might cause the paint to blister because they contain chemicals that strip water-based paints. For this reason, it is recommended that you use a soft cloth dampened with a 50-50 solution of isopropyl alcohol and water. Then rinse off any residue with water and dry with a soft, lint-free cloth. ■

Pen Carousel Cleaning

Clean the pen carousel periodically to remove ink, lint, or dust deposits. Wipe out the pen cap with a cotton swab moistened with alcohol or pen cleaning solution, as shown. Allow the carousel to dry thoroughly before inserting pens.

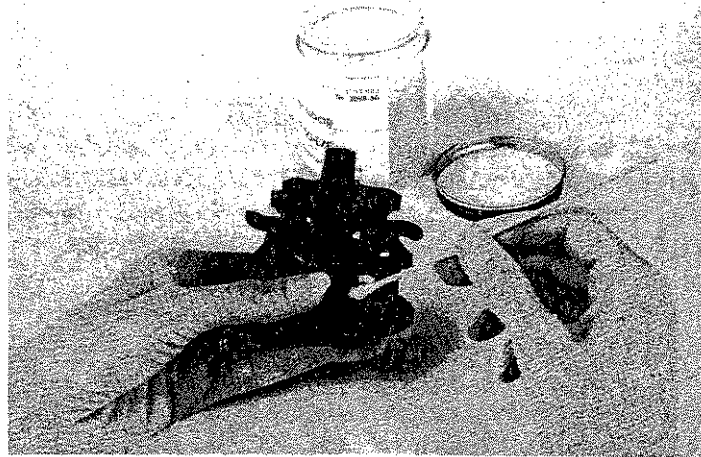

7475-A-39-1

Cleaning the Pen Carousel

Shipment

When the plotter is to be shipped, be sure it is packed in a protective carton. Keep the original packing materials and shipping carton for this purpose. If not available, packing materials and a carton may be ordered through your local Hewlett-Packard Sales and Support Office.

If your plotter is being returned to Hewlett-Packard for service, contact your nearest HP Field Repair Center for complete shipping instructions. In countries without Field Repair Centers, contact your HP Sales and Support Office. You can help assure effective servicing of your plotter by following these guidelines:

1. Follow the maintenance procedures outlined in this manual to verify the malfunction and, if possible, identify the defective area.
2. If you determine that repair is required, you will need to include the following items when your plotter is returned for service.
 - a. A description of the configuration exactly as it was at the time of malfunction, including the computer model number, interface, and other accessories that were in use when the malfunction occurred.

- b. A brief description of malfunction symptoms for service personnel.
 - c. Plots or any other materials that help illustrate the problem area.
 - d. If purchased through an HP dealer, a copy of the sales slip or other proof of purchase to establish the warranty coverage period.
 - e. Serial number of your plotter (located on rear panel).
3. Include your name and address. Also include the telephone number where you may be reached during the day.
 4. Do not include the power cord or other operating accessories with your plotter, unless the problem relates to an accessory.

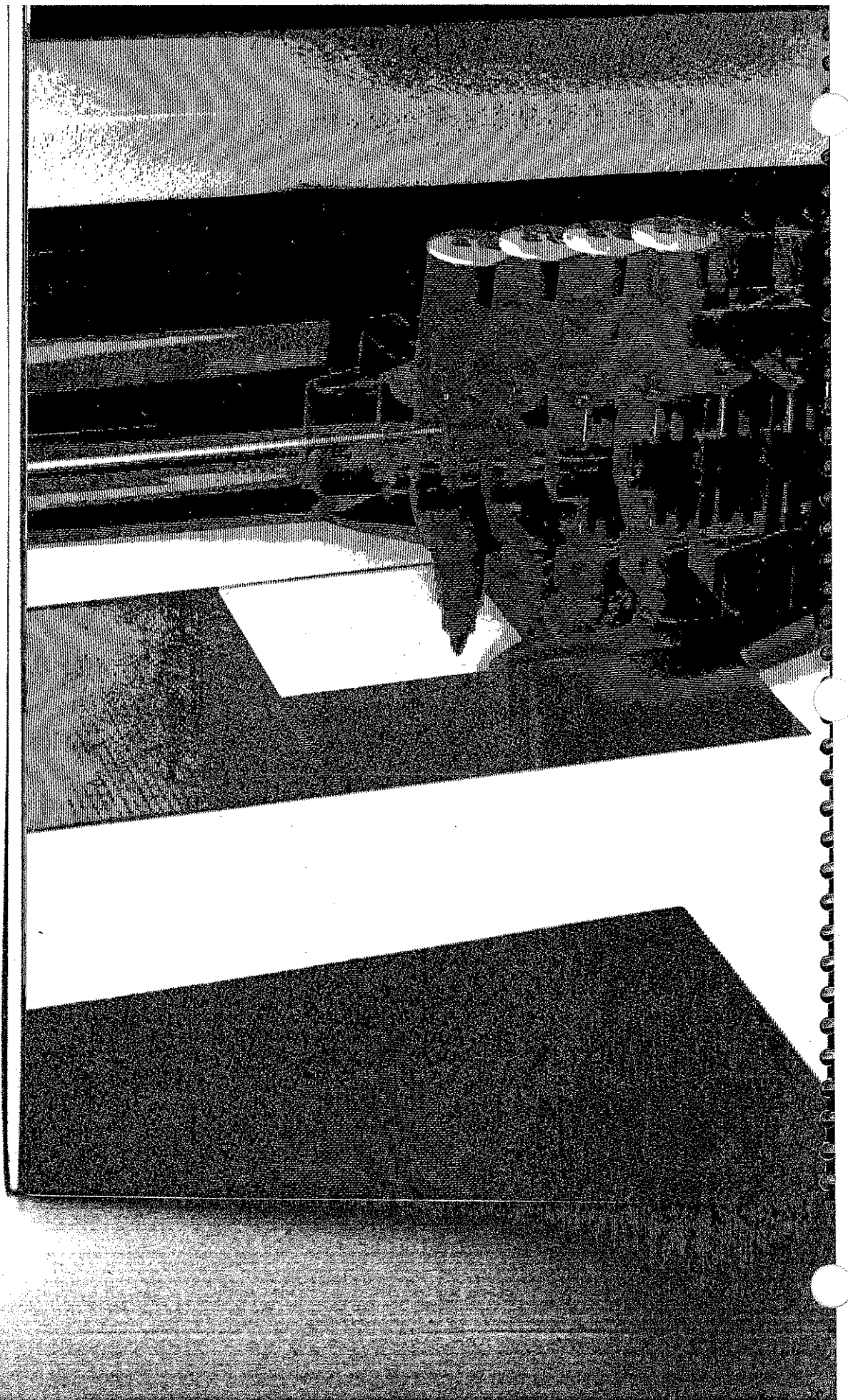

Chapter 2

Plotter Operation

Introduction

In this chapter you will learn about programming languages, the functions of each control and indicator, the plotter's coordinate system, and how to rotate the coordinate system. You will also learn how to load pens and paper and how to determine that the plotter is functional.

Major Feature Locations

The following illustration shows the locations of the major operating features. The pen holder is shown at its power-up position near the right limit of the drawing range. The pen carousel is located on the left side of the plotter and holds up to six pens, which can be accessed by the pen holder.

The pinch wheels and grit-covered drive wheels that move the paper back and forth across the platen are spaced to accommodate either ANSI A and B or ISO A4 and A3 size media. The paper loading lever which raises and lowers the pinch wheels is located on the right side of the platen.

The operating controls and indicators are grouped on the front panel at the right side of the plotter. Configuration and interface controls are located on the rear panel. The controls are explained in detail later in this chapter.

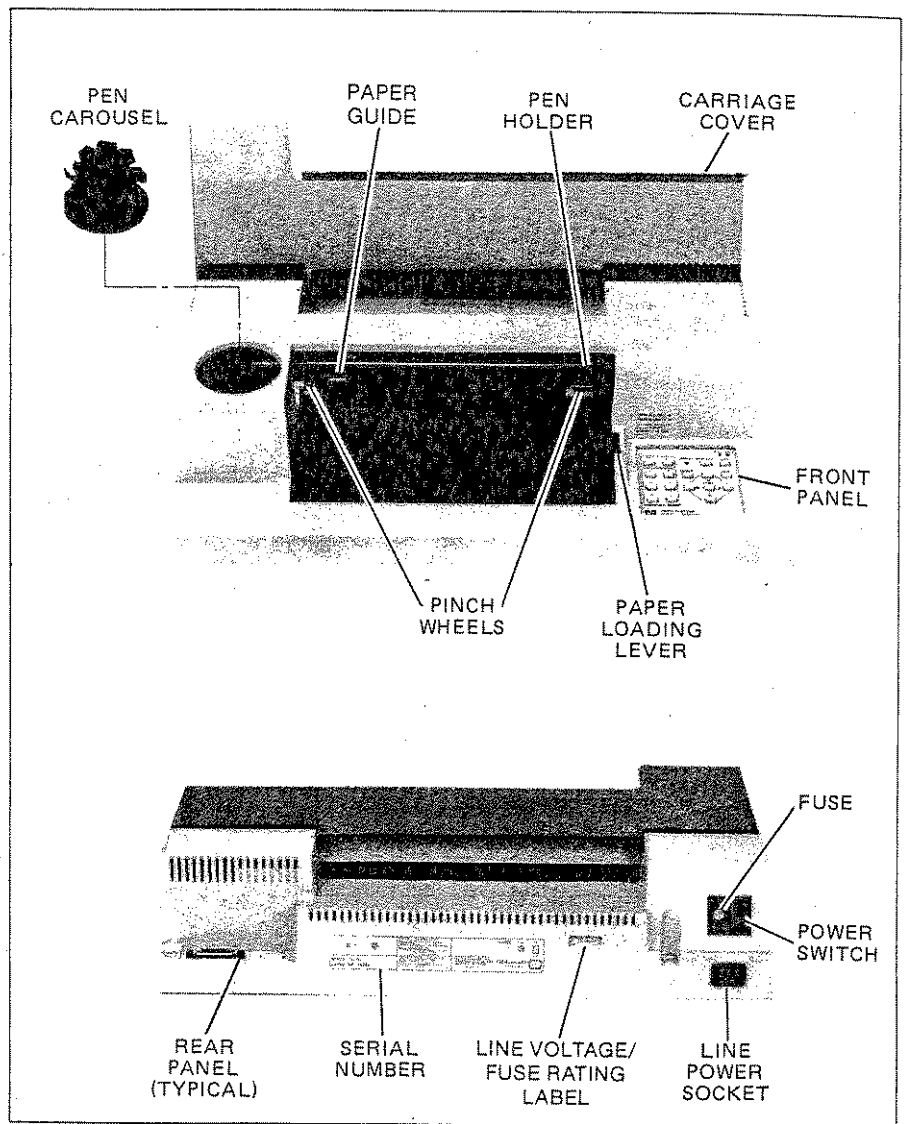

Major Feature Locations

Introduction to Programming Languages

What Is a Program?

A program is an organized set of instructions that tells your computer and plotter to accomplish certain tasks. There are two types of programs that you can use to generate the input data for your graphics plots: prepackaged software programs and user-written software programs. Prepackaged software programs are easy to use and usually do not

require that you have a programming background. The manual supplied with your prepackaged software contains complete instructions for its use. If prepackaged software is not available for your application, it will be necessary to learn the programming languages that the computer and plotter understand.

What Programming Languages Do I Use?

Although there are many programming languages, it is probable that your computer understands BASIC (Beginner's All-purpose Symbolic Instruction Code). BASIC is a common programming language that is used to tell your computer what to do. It uses statements that resemble English, is easy to use, and enables you to perform many complex operations. These operations include computation, data base management, and conditional evaluation of data to control program branching. BASIC also includes input and output statements which allow your computer to communicate with the plotter. Output statements are used to send HP-GL instructions to the plotter. Input statements are used to read responses from the plotter. If you are new to BASIC programming and want to learn, your computer store can probably supply a good BASIC programming manual. If you are using a Hewlett-Packard computer, your computer programming manual contains complete details of the BASIC language version that it implements.

In addition to the computer language, you must also understand the plotter's language (HP-GL) or a high-level graphics programming language, such as AGL.

AGL (A Graphics Language)

AGL is implemented on Hewlett-Packard computers to simplify graphics plotting. AGL statements are an extension of the BASIC programming language. They consist of English words that are usually followed by numeric parameters. These statements describe their graphics plotting function and instruct the computer to send HP-GL instructions to the plotter. One AGL statement often performs a task that would require several HP-GL instructions to perform. Your HP computer documentation is the source of the information you need to write plotting programs using AGL statements.

HP-GL (Hewlett-Packard Graphics Language)

HP-GL is the graphics programming language that is actually sent to and understood by the plotter. HP-GL instructions consist of two-letter mnemonics that are usually followed by numeric parameters. With the exception of certain escape sequence instructions which are used for control of interface functions in an RS-232-C environment, all data received by the plotter is interpreted as HP-GL instructions. You can include HP-GL instructions directly in the computer language output

statements, or you can use AGL statements which the computer encodes and sends to the plotter as HP-GL instructions. The Interfacing and Programming Manual contains complete information about handshaking and programming in HP-GL.

Introduction to the Plotter Coordinate System

The plotter area is that area of the paper in which the pen can draw. This area should be thought of as a two-dimensional Cartesian coordinate system. In this system, the entire plotting area is divided (scaled) into a grid as shown in the following illustration. Each intersection of these grid lines represents a distinct point that is expressed by X- and Y-axis coordinates with respect to the origin point ($X = 0, Y = 0$). For example, the coordinates $X = 4$ and $Y = 5$ define the point at the intersection of the fourth positive grid line along the X-axis and the fifth positive grid line along the Y-axis. These coordinate values are used as parameters in HP-GL instructions to move the pen to any given point in the plotting area.

Grid spacing (resolution) can be in either plotter units, which have a fixed length, or user units, which are variable in length. A plotter unit is 0.02488 mm (0.00098 in.) in length and is the smallest move the plotter can make. The maximum numeric range that the plotter understands is $-32\,768$ to $+32\,767$ for both plotter units and user units.

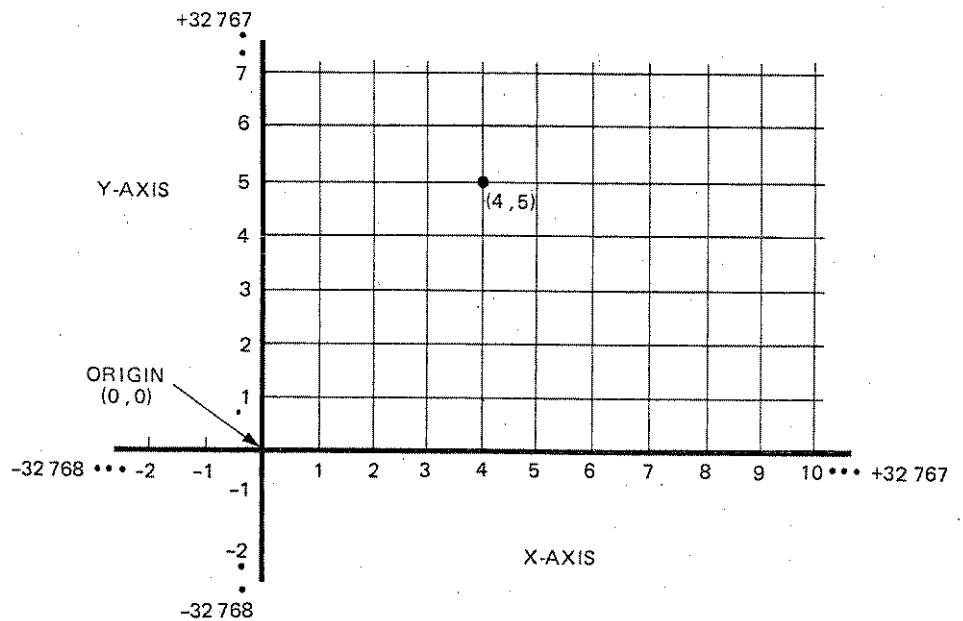

Cartesian Coordinates

Coordinate System Orientation

The location of the coordinate origin (0,0 plotter units) and the orientation of the X- and Y-axis with respect to A and A4 or B and A3 paper sizes are shown in the following diagrams. Hard-clip limits and the approximate default locations of scaling points P1 and P2 are also shown. All of these default conditions are determined by the settings of the US/MET and A4/A3 switches when plotter power is first turned on.

Hard-Clip Limits

The hard-clip limits determine the maximum limits of the pen's motion and the area within which scaling points P1 and P2 can be positioned. Except for narrow margins which are required by the grit wheel paper-moving technology, the hard-clip limits allow plotting on the entire paper surface. The following table shows the maximum plotting range, in plotter units, for all four paper sizes. Note that the plotting ranges in the X- and Y-axis are reversed when the 90-degree rotate function is turned on. Refer to Rotating the Coordinate System in this chapter.

NOTE: The power-up default input window is coincident with the hard-clip limits. The size of the input window can be changed using the HP-GL instruction, IW, to programmatically limit the pen's motion. ■

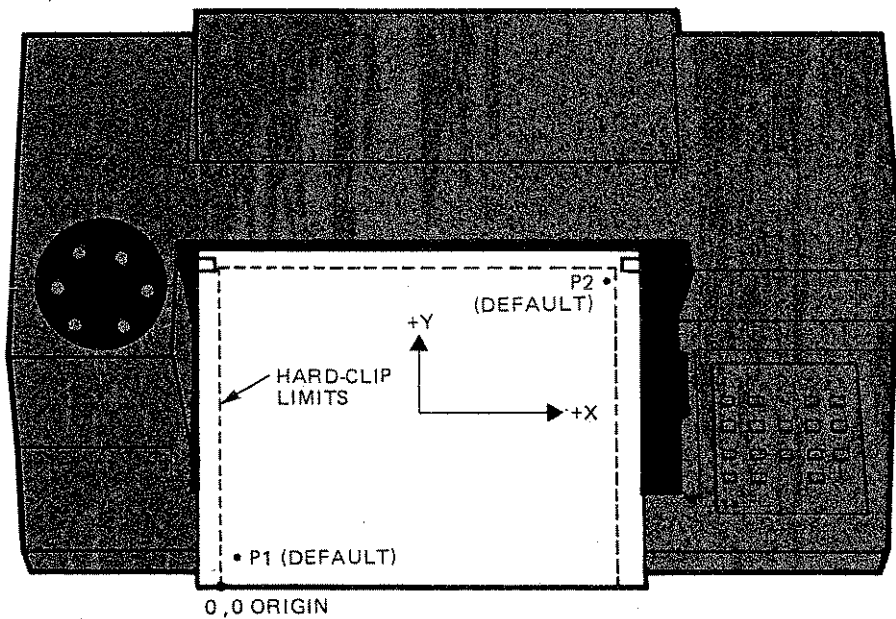

Default Orientation of Plotter Coordinate System (A/A4 Paper)

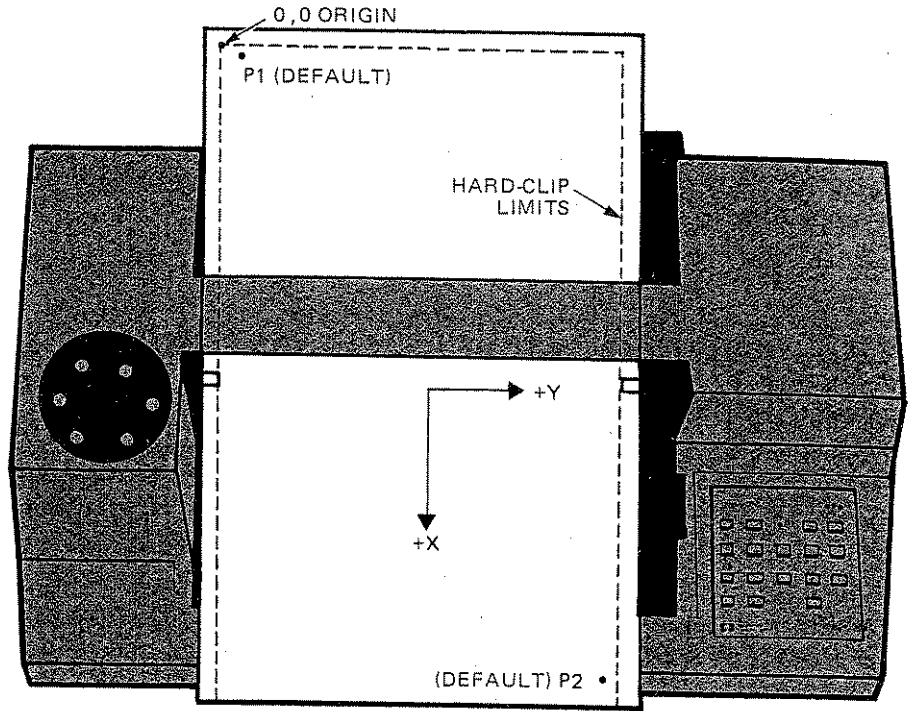

Default Orientation of Plotter Coordinate System (B/A3 Paper)

Maximum Plotting Ranges

Paper Size Settings		Selected Paper Size	Maximum Plotting Range (Plotter Units)	
US/MET	A4/A3		X-Axis	Y-Axis
US	A4	A (8.5 × 11 in.)	0-10 365 (257.8 mm/ 10.15 in.)	0-7962 (198.1 mm/ 7.8 in.)
US	A3	B (11 × 17 in.)	0-16 640 (413.9 mm/ 16.3 in.)	0-10 365 (257.8 mm/ 10.15 in.)
MET	A4	A4 (210 × 297 mm)	0-11 040 (274.6 mm/ 10.81 in.)	0-7721 (192.1 mm/ 7.56 in.)
MET	A3	A3 (297 × 420 mm)	0-16 158 (401.9 mm/ 15.82 in.)	0-11 040 (274.6 mm/ 10.81 in.)

The Scaling Points P1 and P2

On power-up, the default location of scaling point P1 is in the lower-left corner of A/A4 size paper or in the upper-left corner of B/A3 size paper. In each case, the default location of scaling point P2 is in the corner opposite from P1. The exact default coordinate locations of scaling points P1 and P2 are shown in the following table, in plotter units, for the different paper sizes. These default coordinate values define opposite corners of a rectangular area that is centered on the associated size of paper. Regardless of its size, the rectangular area defined by P1 and P2 will hereafter be referred to as the "P1/P2 frame."

Default Coordinate Values for Scaling Points P1 and P2

Paper Size	Default Scaling Points (Plotter Units)	
	P1x,P1y	P2x,P2y
A	250,596	10 250,7796
A4	603,521	10 603,7721
B	522,259	15 722,10 259
A3	170,602	15 370,10 602

HP-GL Scaling

Scaling points P1 and P2 can be used in conjunction with the HP-GL instruction, SC, to enable you to plot in user units that are convenient to your application. The size of the user unit is determined by the physical dimensions of the P1/P2 frame and by the parameters of the SC instruction. These parameters assign user-unit coordinates to P1 and P2 and divide (scale) the entire plotting area, not just the P1/P2 frame, into a user-unit grid. Grid spacing can be anisotropic (unequal in X and Y) or isotropic (equal in X and Y) and each axis can have a different number of user units. For example, the HP-GL instruction SC0,12,0,1000 scales the P1/P2 frame into 12 user units in the X-axis, representing months, and into 1000 user units in the Y-axis, representing total sales in dollars.

Scaling points P1 and P2 retain the assigned user-unit values until scaling is turned off or another SC instruction redefines their user-unit coordinate values. Therefore, the size of a user unit will change with any change in the distance between P1 and P2. This feature allows you to fit the same plot on any size of paper.

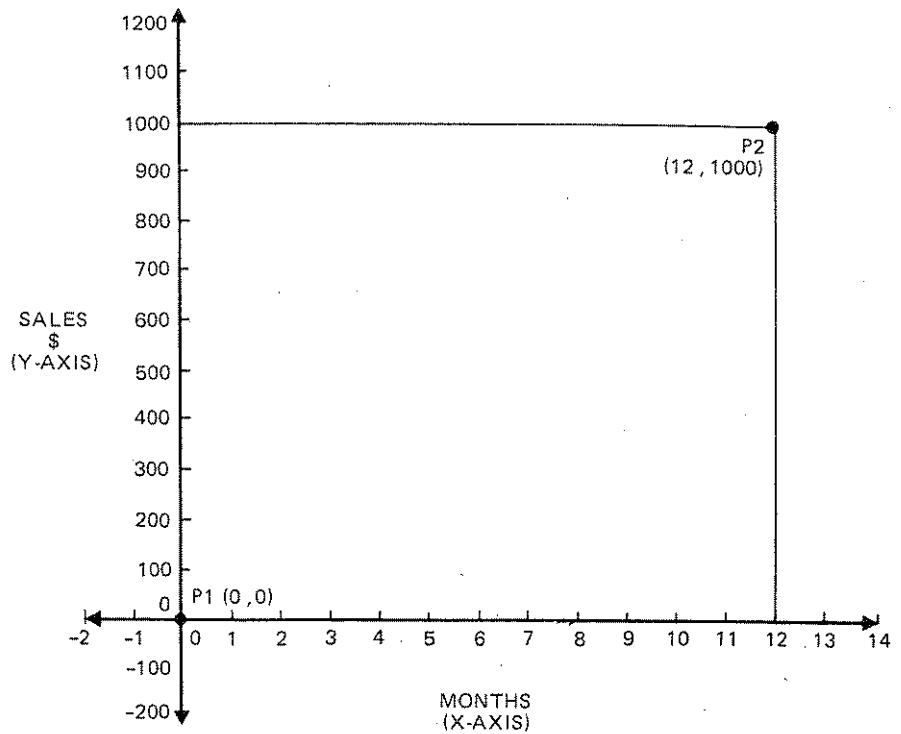

User-Unit Scaling

AGL Scaling

Scaling points P1 and P2 can also be used in conjunction with AGL, and some prepackaged software, to establish software hard-clip plotting limits. In AGL, the PLOTTER IS statement causes the plotter to output the current coordinate locations of P1 and P2, in plotter units. The computer interprets the area defined by P1 and P2 as the maximum software hard-clip plotting limits. Regardless of the size of the software hard-clip plotting limits, the shortest side is scaled from 0 to 100 GDUs (graphic display units). The longest side is scaled from 0 to 100 GDUs times the ratio of the longest side divided by the shortest side. Thus, a square plotting area will have 100 GDUs in each direction, but if the plotting area is twice as long in one direction as the other, the longest side will have 200 GDUs. In this coordinate system, GDUs are the default scaling units and P1 is the 0,0 origin point. AGL also has provisions for defining and plotting in UUs (user units). With this system, AGL programs can produce plots within any area defined by P1 and P2 without modifications to the program. Refer to your HP computer documentation for the information you need to program in AGL.

Setting the Scaling Points

The locations of scaling points P1 and P2 can be changed manually from the front panel or programmatically with the HP-GL instruction IP. Refer to the Interfacing and Programming Manual for instructions on how to set the scaling points programmatically.

The position of P2 can be changed without changing the position of P1. However, when you move P1, P2 automatically moves so that the X- and Y-distances between P1 and P2 remain the same. You can leave P2 in its automatic new position, or you can set a different position for P2. You can reestablish default positions for P1 and P2 by any of the following methods:

- power-up initialization,
- execution of either the HP-GL instruction, IN, or the instruction IP without parameters,
- simultaneously pressing **ENTER** and **VIEW** (front-panel reset).

Whenever the plotter is turned on, the following procedure can be used for manually relocating P1 and P2.

NOTE: Always set P1 first, since P2 moves when P1 is moved. ■

1. Using the cursor pushbuttons (arrow pushbuttons), position the pen at the new location chosen for P1.
2. Press **ENTER** simultaneously with **P1** to store the new location of P1.
3. Using the cursor pushbuttons, position the pen at the location chosen for P2.
4. Press **ENTER** simultaneously with **P2** to store the new location of P2.
5. To check the new points, press **P1**, then press **P2**. The pen should move to the new P1 point, then to the new P2 point.

Preparing Equal-Sized Plots

Automatic positioning of P2 as P1 is moved can be used advantageously in applications such as preparing two equal-sized plots on the same page. This function is illustrated in the following diagram. Use the procedure given for setting the scaling points to establish the first P1/P2 frame. When plotting is completed, set the new position for P1 for the second plot. P2 moves proportionately and automatically establishes an equal-sized P1/P2 frame for the second plot.

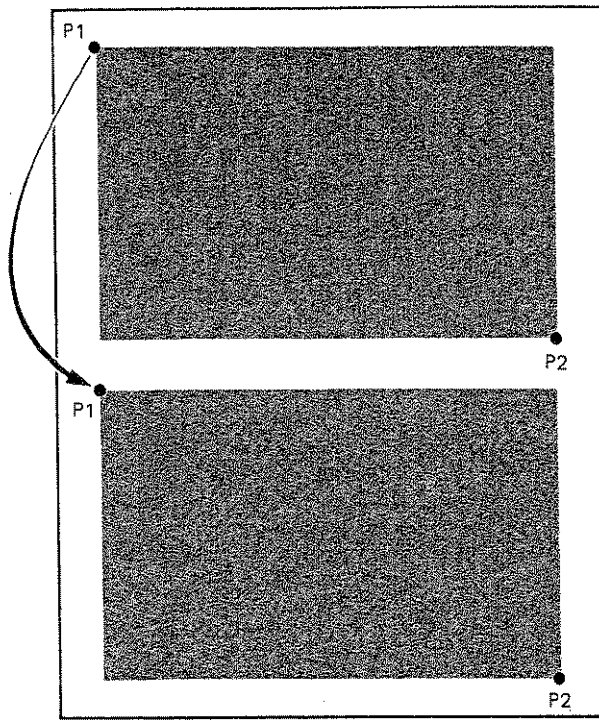

Preparing Equal-Sized Plots

Squeezing the Scaling Area

When a P1/P2 frame is established within the plotting area, and then P1 is moved so that P2 intersects the hard-clip limits, a new P1/P2 frame is established at the point of intersection. This feature is illustrated as follows:

DETAIL A: Illustrates the initial P1/P2 frame.

DETAIL B: Illustrates moving P1 to a new position. P2 moves proportionately until the hard-clip limit is reached. At this point, P2 stops moving with P1 and the distance between P1 and P2 changes.

DETAIL C: Illustrates moving P1 back to its original location. P1 and P2 maintain the relationship established in Detail B, thus producing a "squeezed" P1/P2 frame.

DETAIL "A"

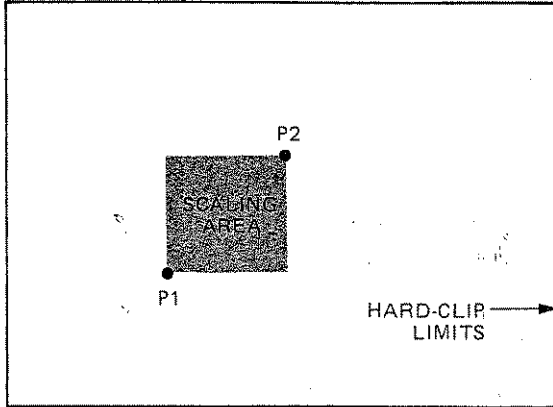

DETAIL "B"

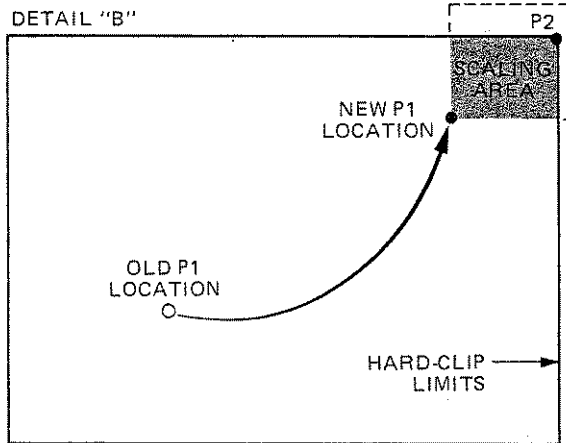

DETAIL "C"

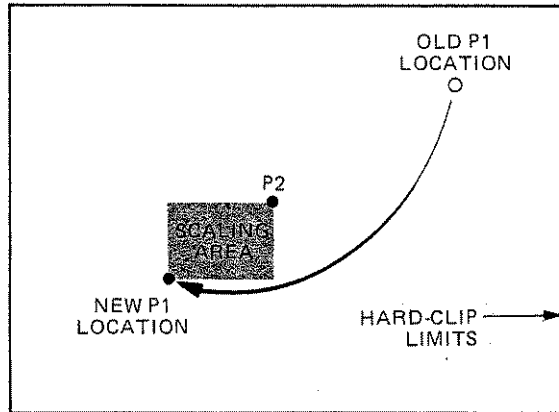

Squeezing The Scaling Area

Rotating the Coordinate System

The plotter coordinate system can be manually rotated 90 degrees from its default orientation as shown in the following illustrations for A/A4 and B/A3 paper sizes. The rotate function is effective whether plotting is being done in plotter units or user units.

The rotate function can be manually invoked from the front panel, using the **ENTER + FAST** button combination, or programmatically, using the HP-GL instruction, **RO**. The only difference is the rotated locations

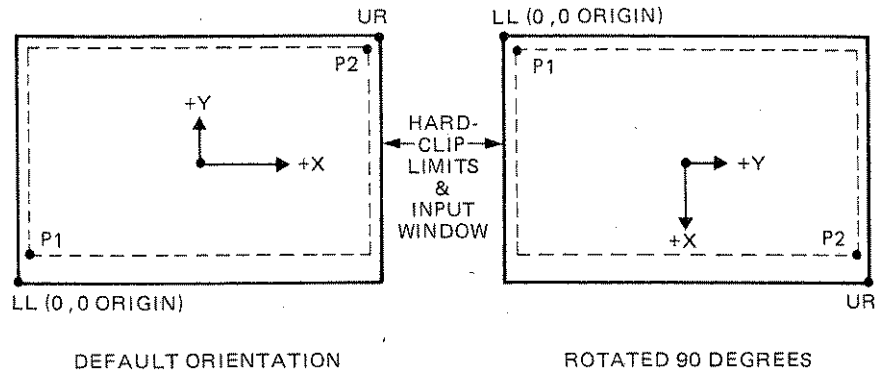

Front-Panel Rotation on A/A4 Size Paper

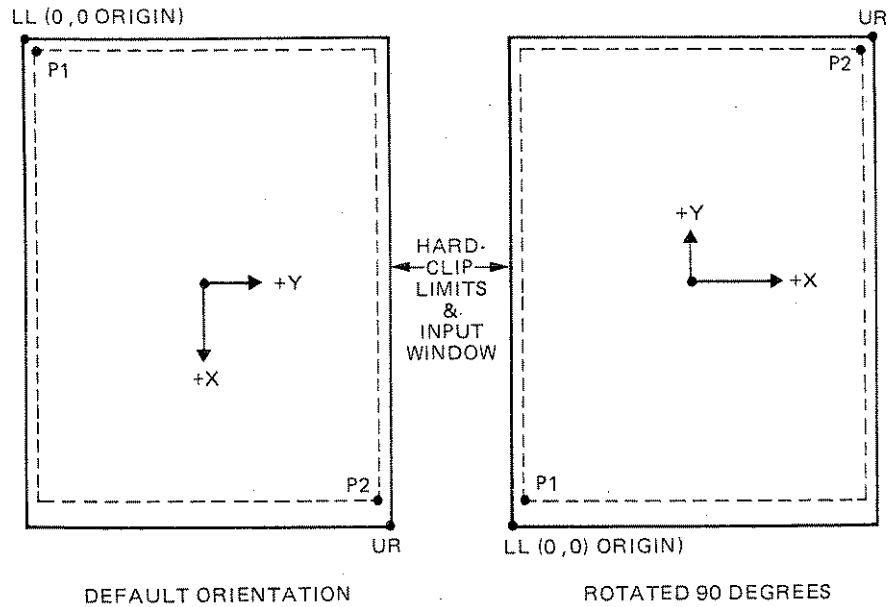

Front-Panel Rotation on B/A3 Size Paper

of P1 and P2 and the physical size of the input window. Whether invoked manually or programmatically, rotations are not cumulative, and the rotate function can only be toggled on or off.

When the 90-degree rotate function is invoked with the **ENTER + FAST** buttons, the default input window remains coincident with the hard-clip limits and P1 and P2 assume new rotated default coordinate locations inside the hard-clip limits. These new P1/P2 values are shown in the following table. Note that the physical location and size of the P1/P2 frame are not affected by the front-panel rotate function.

Rotated Default Coordinate Values for Scaling Points P1 and P2

Paper Size	Rotated Default Scaling Points (Plotter Units)	
	P1x,P1y	P2x,P2y
A	154, 244	7354, 10 244
A4	0, 610	7200, 10 610
B	283, 934	10 283, 16 134
A3	607, 797	10 607, 15 997

Plotter Operation

When the 90-degree rotate function is invoked with an RO90 instruction, P1 and P2 retain their current coordinate values and may therefore be rotated outside the hard-clip limits as shown in the following illustration. The default input window is also rotated, but its physical size is clipped to a square area by the hard-clip limits. Note that the input window limits programmed pen motion to the window area, but the pen can still be moved anywhere within the hard-clip limits using the front-panel cursor buttons. The input window can be expanded to the hard-clip limits and P1 and P2 can be defaulted to the rotated default coordinate values using the HP-GL instructions, IW and IP, without parameters.

Whether invoked manually or programmatically, the physical size and location of the hard-clip limits are not affected by the rotate function. However, the defined lower-left (LL) and upper-right (UR) corners of the hard-clip limits are rotated to maintain the same relationship with respect to the 0,0 origin point. The coordinate values for UR are determined by paper size and the state of the rotate function; but, the coordinate values for LL will always be 0,0 regardless of paper size and the state of the rotate function. The current plotter unit coordinate values for LL and UR can be obtained by executing the HP-GL instruction, OH.

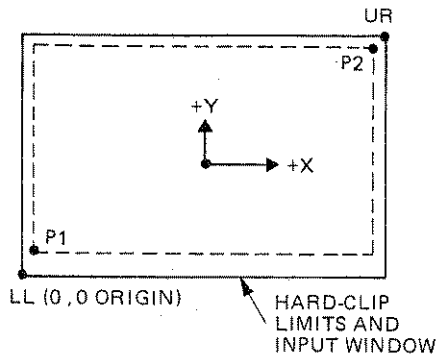

DEFAULT ORIENTATION

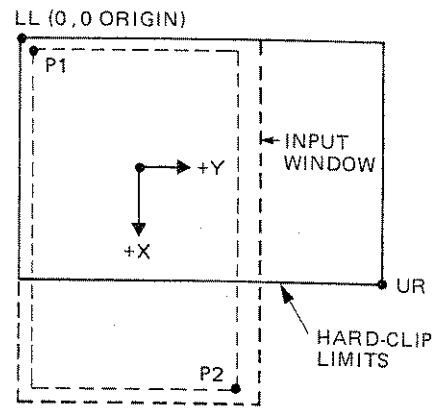

ROTATED 90 DEGREES

HP-GL RO90 Rotation on A/A4 Size Paper

Controls and Indicators and Their Functions

In addition to the ~ LINE power switch and paper loading lever, there are three categories of operator controls: front panel, configuration, and interface.

Front-panel controls are used to toggle between either ANSI A and B or ISO A4 and A3 paper sizes, to manually control pen and paper movement, and to change the locations of scaling points P1 and P2. They can also be used for interaction with a running program. This interaction includes entry of digitized points, pen selection, and program suspension without loss of data. All front-panel controls are common to both HP-IB and RS-232-C interface options.

Configuration controls consist of two switches on the rear panel. These switches determine the power-up default paper size, hard-clip limits, and P1/P2 coordinate values. The switches are common to both HP-IB and RS-232-C interface options.

Interface controls establish the conditions under which communication between the plotter and computer will occur. Different interface controls are required for the HP-IB and RS-232-C interface options.

All operator controls, including the controls which are unique to the HP-IB and RS-232-C interface options, are shown in the following illustration. Individual controls and indicators are shown adjacent to their functional descriptions.

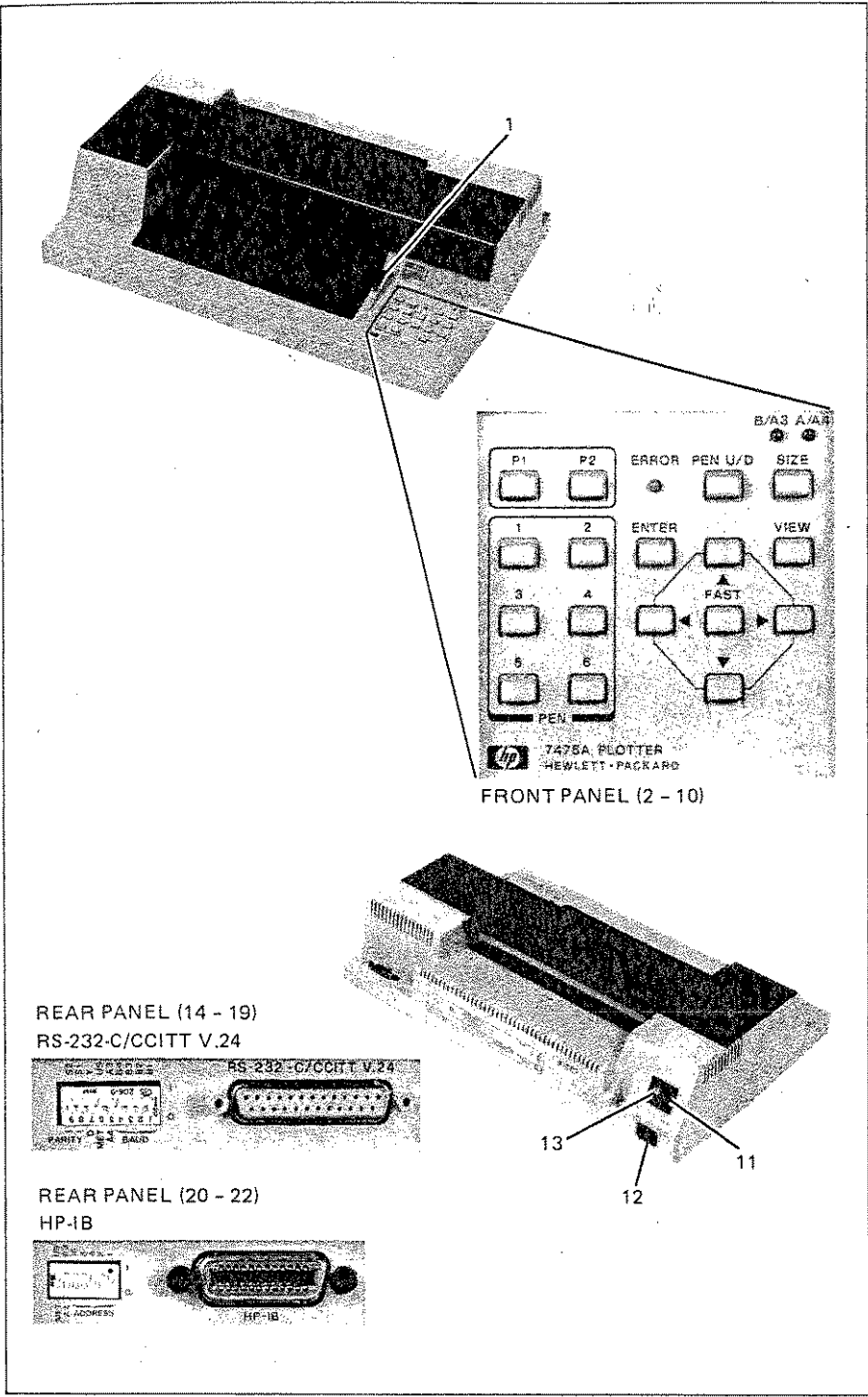

FRONT PANEL (2 - 10)

REAR PANEL (14 - 19)
RS-232-C/CCITT V.24

REAR PANEL (20 - 22)
HP-IB

Operator Controls

Front Panel

1.

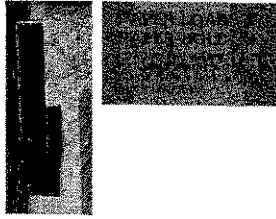

PAPER LOAD ↑/PAPER HOLD ↓ — Moving the paper loading lever to the **PAPER LOAD ↑** position turns on the **ERROR** light and initiates the following:

- a. Raises the pinch wheels and returns any pen currently held in the pen holder to the pen stall from which it was selected, or into the lowest-numbered empty position if its original carousel position has since become unavailable. The pen holder moves to the right side of the platen.
- b. Aborts any in-process HP-GL vector or area fill command.

Returning the paper loading lever to the **PAPER HOLD ↓** position turns off the **ERROR** light and initiates the following:

- a. Lowers the pinch wheels to secure the plotting medium. The plotter assumes new paper has been loaded, but maintains any previously set P1/P2 coordinate values.
- b. Cancels any pending error (**ERROR** light blinking) due to having received a move command with the pinch wheels up.

NOTE: If an I/O error or an HP-GL error other than number 8 is set, the **ERROR** light will continue blinking. ■

2.



P1/P2 — Pressing **P1** or **P2** causes the plotter to raise the pen and move it to the current coordinate location of scaling point **P1** or **P2**. On power-up, the default **P1** location is in the lower-left corner of A/A4 size paper or in the upper-left corner of B/A3 size paper. In each case, the default **P2** location is in the corner opposite from **P1**. The exact default coordinate locations of scaling points **P1** and **P2** are listed in the tables given under the paragraphs entitled *The Scaling Points P1 and P2* and *Rotating the Coordinate System*.

Pressing **P1** or **P2** simultaneously with the **ENTER** pushbutton establishes the current pen location as the new coordinates of scaling point **P1** or **P2**.

3.

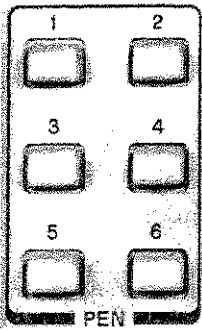

PEN — Pressing any **PEN** pushbutton causes the plotter to retrieve the corresponding numbered pen from the carousel, if it is present. If the corresponding numbered carousel position is empty, the pen holder returns to its previous location. The plotter stores its current pen, if any, before it retrieves the newly selected pen. The old pen is stored into the carousel position from which it came, or into the lowest-numbered empty position if its original carousel position has since become unavailable. After the pen is retrieved, the pen holder returns to its previous location. If a plot is in progress when the **PEN** pushbutton is pressed, the plot is paused and does not resume until after the pen is retrieved and the pen holder returns to its previous location.

Pressing **ENTER** simultaneously with any **PEN** pushbutton causes the plotter to store its current pen into the corresponding numbered carousel position, if possible. If the selected carousel position is occupied, the plotter stores its current pen into the lowest-numbered empty position, if any. The pen holder then returns to its previous location.

4.

ERROR



ERROR — This multi-purpose **ERROR** light can be off, on, or blinking as follows:

- a. When the **ERROR** light is on but not blinking, it indicates the **VIEW** pushbutton has been pressed or the paper loading lever is in the **PAPER LOAD** † position (pinch wheels up).
- b. When the **ERROR** light is blinking brightly, it indicates the plotter has detected an I/O error, a paper moving error, or an HP-GL error for which the error mask has been set. For a description of errors, refer to instructions IM, OE, and ESC.E in the Interfacing and Programming Manual.

NOTE: When the plotter is not active, the **ERROR** light will blink very dimly approximately every five seconds. This indicates internal power supply calibration is being performed. ■



PEN U/D — Pressing the **PEN U/D** pushbutton reverses the current pen state (up or down). It can be used in conjunction with the cursor pushbuttons to draw lines or to digitize a point. When the **PEN U/D** pushbutton is pressed during program execution, it is equivalent to executing an HP-GL PU or PD instruction.



B/A3, A/A4 — These two lights indicate the currently selected paper size. When the rear-panel **US/MET** switch is set to **US**, they indicate A or B paper size, but when the switch is set to **MET** (metric), they indicate A4 or A3 paper size.

NOTE: Since one of the two paper-size lights is always on, these lights also serve as power-on indicators. Also note that the current paper-size light will blink whenever the plotter receives the HP-GL instruction, DP. This indicates a point can be digitized using the **ENTER** pushbutton. ■

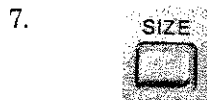

SIZE — Pressing the **SIZE** pushbutton simultaneously with the **ENTER** pushbutton selects the alternate paper size. The following actions occur each time a new paper size is selected:

- a. The size status indicated by the **B/A3** and **A/A4** lights is reversed.
- b. The plotter assumes a new piece of paper is loaded and the pen holder lifts and moves to the extreme right.
- c. The equivalent of executing an HP-GL DF instruction establishes default conditions.
- d. P1 and P2 are set to their default coordinate locations.
- e. The input window is set to the new hard-clip limits.

NOTE: The state of the rotate function is not affected. ■



VIEW — Pressing this latching pushbutton turns on the **ERROR** light, suspends plotting, raises the pen, and moves the paper so it is fully extended. In this state you can manually substitute pens and view the entire plotting area. Pressing the **VIEW** pushbutton again turns off the **ERROR** light, returns the pen to its previous coordinates and status (up or down), and plotting resumes.

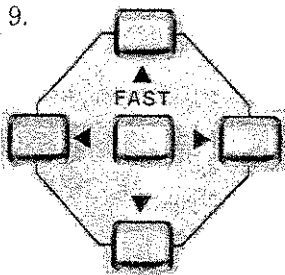

FAST — These five cursor pushbuttons are used to move the pen within the hard-clip limits as follows:

- Pressing a cursor pushbutton moves the pen in the direction of the arrow.
- Pressing adjacent cursor pushbuttons moves the pen at a 45-degree diagonal between the two arrow directions.
- When **FAST** is pressed in conjunction with any cursor pushbutton, cursor speed is four times greater.
- Pressing **FAST** by itself pauses plotting as long as the pushbutton is held down.

NOTE: Pressing any cursor pushbutton during plotting will pause the plot and perform the appropriate cursor motion. Plotting will resume at the new location when the cursor pushbutton is released. ■



ENTER — This multi-purpose pushbutton is used for changing paper size and the locations of scaling points P1 or P2, rotating the coordinate system, storing the currently held pen, resetting the plotter to power-up default conditions, and digitizing.

The enter function is non-latching. This means the **ENTER** pushbutton must be pressed simultaneously with one of the following pushbuttons to initiate the defined action.

ENTER + SIZE — Selects the alternate paper size and initiates the actions defined for the **SIZE** pushbutton.

ENTER + P1/P2 — Defines the current pen location as the new P1 or P2 scaling point. Remember to set P1 first, since P2 moves when P1 is moved. Refer to the section in this chapter entitled Setting the Scaling Points.

ENTER + FAST — Rotates the coordinate system 90-degrees from its current state. Refer to the section in this chapter entitled Rotating the Coordinate System.

ENTER + PEN# — Stores the pen currently held in the pen holder into the corresponding numbered carousel location, if possible. The pen holder then returns to its previous location.

ENTER + VIEW — Resets all power-up default conditions. This is the same as turning the power off and then on again.

NOTE: If the pen holder is moved manually, or an obstruction is encountered, the servo motors become inoperative and the **ERROR** light starts blinking. In this case, the plotter will not respond to **ENTER + VIEW** or any other front-panel control. The only way to correct this situation is to remove the obstruction and cycle the **~LINE** switch to **OFF**, then **ON** again. ■

ENTER (digitizing) — The current paper-size light (**B/A3** or **A/A4**) will blink when the plotter receives the HP-GL instruction, **DP**. This blinking light indicates the digitizing mode is initiated and the pen should be moved to the point to be digitized. If **ENTER** is then pressed, the paper-size light stops blinking and the actual X- and Y-coordinates of the point and the pen status (up or down) are stored in the plotter's output buffer. This data is output to the computer when the plotter receives the HP-GL instruction, **OD**. Refer to the Interfacing and Programming Manual for complete digitizing instructions.

Rear Panel

11.



This rocker switch controls application of ac power to the plotter (refer to Line Voltage Selection).

12.  This is the power-input socket (refer to Power Cords).

13.  This is the line power fuse (refer to Fuse Protection).

Option 001 (RS-232-C/CCITT V.24)

14.  This RS-232-C/CCITT V.24 compatible, 25 pin, female type connector is used to connect the plotter to a host computer.

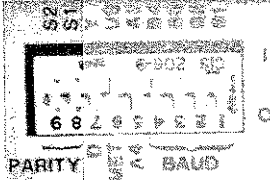
15.  **PARITY S1** — This rocker switch controls whether parity generation and checking will occur for data transmission. If set to "0," no parity generation or checking will occur. If set to "1," parity generation and checking will be odd or even depending upon the setting of the S2 switch.

PARITY S2 — This rocker switch establishes the type of parity to be used, either odd or even, when the S1 switch is set to "1." Setting S2 to "1" establishes odd parity; "0" establishes even parity.

16.  **D/Y** — This rocker switch is used to establish either programmed "on" or programmed "off" operation status when the plotter is turned on.

Position **D** is used when the plotter is directly connected to a computer (endline operating environment). In this position, the plotter powers-up in the programmed "on" operating state. The plotter will respond to all HP-GL and escape sequence instructions, except the ESC.) or ESC. Z plotter "off" instructions.

Position **Y** is used when the plotter is connected between a terminal and computer (eavesdrop operating environment). The plotter powers-up in the programmed "off" operating state. In this state, the plotter will pass information between the terminal and computer; but only responds to a plotter "on," ESC.(or ESC.Y instruction. After receipt of a plotter "on" instruction, the plotter will respond to all HP-GL and escape sequence instructions.

Plotter Operation

NOTE: The plotter's ~LINE switch must be ON in order to have any communication between the terminal and the computer. ■

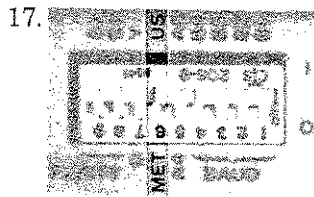

US/MET — This rocker switch is used in combination with the A4/A3 rocker switch to select one of four possible default paper sizes with the appropriate sized hard-clip limits and default P1/P2 coordinate values. The positions of the US/MET and A4/A3 switches are checked only when power is first turned on, or when a front-panel reset is invoked using the ENTER + VIEW pushbuttons. Refer to the A4/A3 switch for combination switch settings.

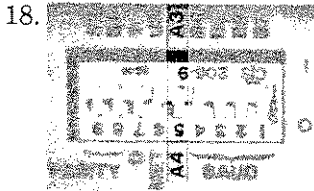

A4/A3 — This rocker switch is used in combination with the US/MET rocker switch to select the default paper size. Combination switch settings of the US/MET and A4/A3 switches are as follows:

Combination Switch Settings	Selected Default Paper Size
US/A4	ANSI A
US/A3	ANSI B
MET/A4	ISO A4
MET/A3	ISO A3

After power is turned on, paper size can be toggled between A and B or A4 and A3 sizes using the front-panel ENTER + SIZE pushbuttons.

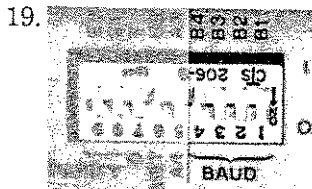

BAUD — These four rocker switches are used to select a baud rate which corresponds with your computer's data transmission rate. The baud rate is selected by setting switches B1 through B4 to the appropriate binary bit positions defined in the following table. When set to "external," the baud rate is generated by an external clock connection at pin 17 of the RS-232-C/CCITT V.24 connector. For specifications of the external clock, refer to Chapter 10 in the Interfacing and Programming Manual.

Baud Rate	One Stop Bit				Two Stop Bits			
	B4	B3	B2	B1	B4	B3	B2	B1
External	—	—	—	—	0	0	0	0
75	—	—	—	—	0	0	0	1
110	—	—	—	—	0	0	1	0
150	0	0	1	1	—	—	—	—
200	0	1	0	0	—	—	—	—
300	0	1	0	1	1	0	1	1
600	0	1	1	0	1	1	0	0
1200	0	1	1	1	1	1	0	1
2400	1	0	0	0	1	1	1	0
4800	1	0	0	1	1	1	1	1
9600	1	0	1	0	—	—	—	—

Option 002 (HP-IB)



This 24-pin HP-IB connector is used to connect the plotter to a host computer or other HP-IB device.

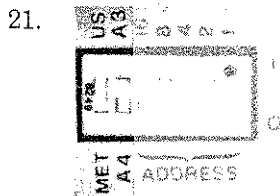

US/MET and A4/A3 — These two rocker switches are common to the HP-IB and RS-232-C interface options. Refer to the Option 001 (RS-232-C/CCITT V.24) controls for their functional description.

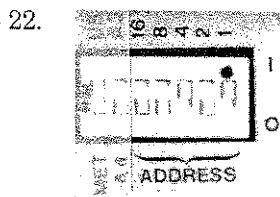

ADDRESS — These five rocker switches are used to establish the plotter address value. The plotter address is selected by setting each switch to the appropriate binary bit position defined in the following table. The plotter is set to an address code of 05 at the factory. This corresponds to a listen character of “%” and a talk character of “E.”

The plotter is in listen-only mode when all five switches are set to “1.” In this mode, the plotter does not have an address, but listens to all data transmitted on the bus. In listen-only mode the plotter cannot be placed in a talker-active state and will not respond to a serial or parallel poll.

NOTE: Listen-only mode is not compatible with most software packages and plotter ROMs. ■

Address Switch Positions

Address Characters		Address Switch Settings					Address Codes	
Listen	Talk	16	8	4	2	1	Decimal	Octal
SP	@	0	0	0	0	0	0	0
!	A	0	0	0	0	1	1	1
"	B	0	0	0	1	0	2	2
#	C	0	0	0	1	1	3	3
\$	D	0	0	1	0	0	4	4
	E	0	0	1	0	1		
&	F	0	0	1	1	0	6	6
'	G	0	0	1	1	1	7	7
(H	0	1	0	0	0	8	10
)	I	0	1	0	0	1	9	11
*	J	0	1	0	1	0	10	12
+	K	0	1	0	1	1	11	13
,	L	0	1	1	0	0	12	14
-	M	0	1	1	0	1	13	15
.	N	0	1	1	1	0	14	16
/	O	0	1	1	1	1	15	17
0	P	1	0	0	0	0	16	20
1	Q	1	0	0	0	1	17	21
2	R	1	0	0	1	0	18	22
3	S	1	0	0	1	1	19	23
4	T	1	0	1	0	0	20	24
5	U	1	0	1	0	1	21	25
6	V	1	0	1	1	0	22	26
7	W	1	0	1	1	1	23	27
8	X	1	1	0	0	0	24	30
9	Y	1	1	0	0	1	25	31
:	Z	1	1	0	1	0	26	32
;	[1	1	0	1	1	27	33
<	\	1	1	1	0	0	28	34
=]	1	1	1	0	1	29	35
>	^	1	1	1	1	0	30	36
?	-	1	1	1	1	1	31	37

← preset

← Reserved for HP Desktop Computer Address

← Sets Listen-only Mode

Plotter Operation

Setting Up the Plotter

Setting up your plotter is a simple procedure which consists of loading pens into the carousel, loading the carousel and plotting medium into the plotter, and turning on the plotter. The following paragraphs

describe these procedures and include instructions for choosing the correct pen and medium combinations.

Choosing the Correct Pen and Medium

To obtain plots of the highest quality, it is important to use pens and media that are matched to your application. Two types of fiber-tip pens are recommended: one for plotter paper and one for transparency film. The top of each pen is marked, in a color that matches the pen's ink, with a three-character code. The first character denotes the media on which the pen is designed to draw. The "P" is for plotter paper; "T" is for transparency film. The second and third characters specify, in millimetres, the approximate line width that the pen will draw.

Loading Pens and the Carousel

The following procedure describes how to load pens into the carousel and how to load the carousel into the plotter.

1. Select the pen type and pen colors to be loaded into each position of the carousel. One or more of the pen positions may be used.
2. Uncap and load each pen into the carousel as follows. Refer to the following photographs.
 - a. Hold the carousel and depress the pen-capping mechanism.
 - b. Position the pen collar just below the rounded notch and slide the pen straight into the pen-holding jaws.
 - c. Release the pen-capping mechanism.
3. Place the carousel on the spindle in the plotter. Rotate the carousel until it drops into position on the spindle. No force is required.

NOTE: To remove the carousel, lift it straight up. To prevent damage to the pen tip, always depress the pen-capping mechanism before removing a pen from the carousel. ■

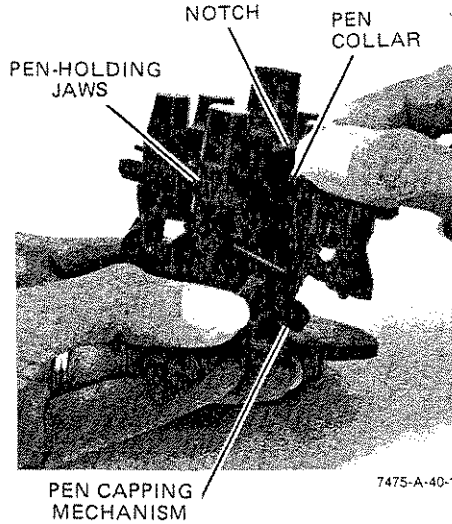

Loading the Pens and the Carousel

Loading the Plotting Medium

The plotter is designed to be used with HP paper and pens. Use of other paper may cause poor line quality. For best results, order papers listed under Accessories Available. To load paper, proceed as follows:

1. Set the **US/MET** and **A4/A3** switches on the rear panel to the appropriate positions shown below that correspond with the paper size being used.

Combination Switch Settings	Selected Default Paper Size
US/A4	ANSI A
US/A3	ANSI B
MET/A4	ISO A4
MET/A3	ISO A3

NOTE: The positions of the **US/MET** and **A4/A3** switches are checked by the plotter only when power is first turned on, or when a front-panel reset is invoked using the **ENTER + VIEW** pushbuttons. After power is turned on, paper size can be toggled between A and B or A4 and A3 sizes using the front-panel **ENTER + SIZE** pushbuttons. ■

2. Check that the right pinch wheel is properly positioned for the paper being used. Refer to the following illustrations.

NOTE: If necessary, snap the spacer off the shaft, slide the pinch wheel to the proper position, and snap the spacer back onto the shaft. ■

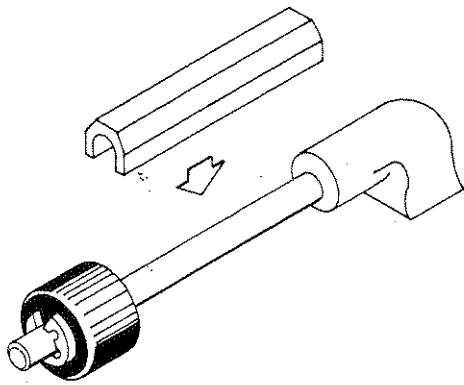

Pinch Wheel Position for A and B Size Paper

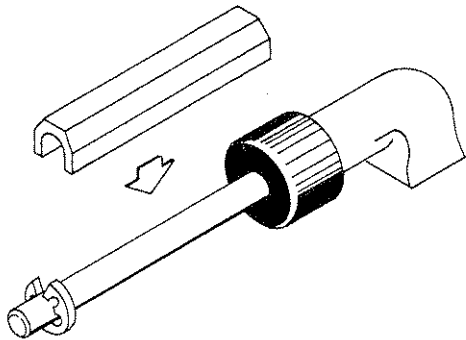

Pinch Wheel Position for A4 and A3 Size Paper

3. Move the paper loading lever to the **PAPER LOAD** ↑ position. This raises the pinch wheels. It also stores and caps the pen to avoid getting ink on the new paper.
4. Lay a sheet of paper on the platen surface so the paper is aligned with the paper guide (the white line at the left rear of the platen) and the left edge of the platen. A and A4 size paper are loaded with the long side horizontal. B and A3 size paper are loaded with the long side vertical. Refer to the following illustration.
5. Move the paper loading lever to the **PAPER HOLD** ↓ position. This lowers the pinch wheels to secure the paper and allow it free movement.

Plotter Operation

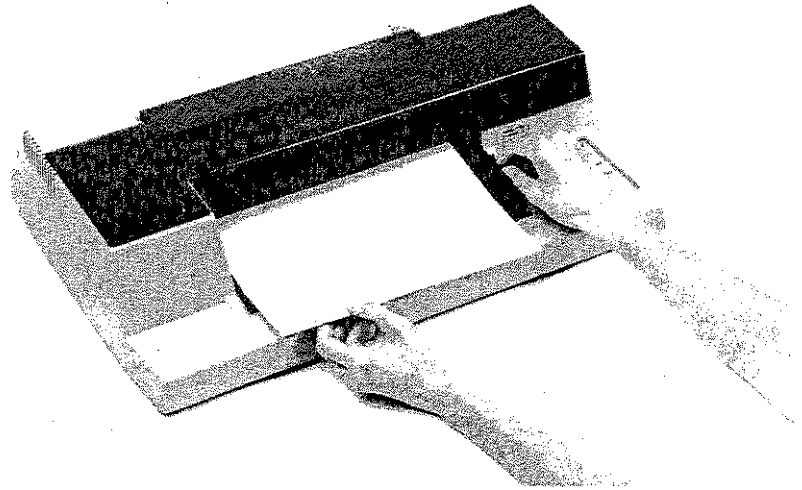

Loading A/A4 Size Paper

7475-A-42-1

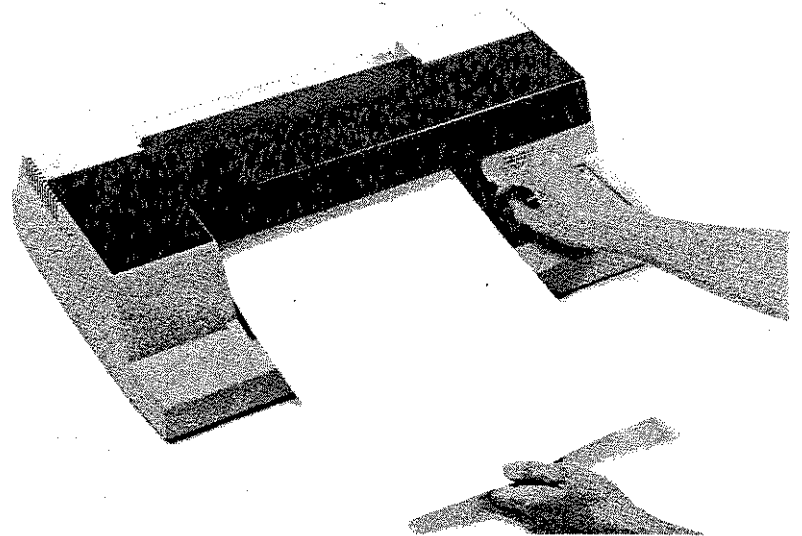

Loading B/A3 Size Paper

7475-A-43-1

Turning On the Power

The plotter performs an initialization cycle when ac power is applied. The initialization cycle sets all plotter functions to their default conditions (conditions assumed by the plotter in the absence of an actual instruction). Apply power to the plotter as follows:

1. Using the power cord supplied, connect the plotter to a grounded (three-wire) ac outlet.

CAUTION

To prevent possible damage, ensure the plotter is properly configured for the line voltage in your area. Refer to Input Power Requirements, Chapter 1.

2. Set the \sim LINE switch to ON. The following power-up initialization will occur:
 - a. The ERROR light turns on momentarily.

NOTE: if the paper loading lever is in the PAPER LOAD \uparrow position, the ERROR light turns on momentarily, then turns on steadily when the power-up initialization cycle is completed. ■
 - b. The plotter assumes a new piece of paper has been loaded, checks the settings of the paper size switches, and performs the necessary pen holder movements to initialize the X- and Y-coordinate axes. The pen holder is then positioned at the right hard-clip limit.
 - c. In addition to establishing the appropriate hard-clip limits and P1/P2 frame, the power-up initialization sets the functions listed in the following table to the indicated conditions. Refer to the Interfacing and Programming Manual for the explanation of each function.

After power-up initialization is completed, the first pen select command will cause the carousel to be initialized. The pen select command can be invoked programmatically with an HP-GL command or manually with the PEN pushbuttons. Carousel initialization consists of backing the carousel around to its stop before it is advanced to the position that corresponds with the pen select command.

NOTE: The tapping noise is normal. It is generated by the carousel-advance mechanism. ■

Paper initialization is performed after the carousel is initialized or when the plotter receives its first move command, depending upon which occurs first. The command to move can be invoked programmatically with an HP-GL command or manually with the P1, P2, or PEN pushbuttons. The cursor pushbuttons will not cause the paper to be initialized. Paper initialization consists of fully retracting the paper and returning it to the starting position prior to completing the commanded move. This initialization allows the grit wheels to put their registration marks on the paper before plotting begins.

Power-Up Default Conditions

Plotter Operation

Function	Equivalent Instructions	Condition
Plotting mode	PA;	Absolute (plotter units)
Rotation	RO;	0 degree (default orientation)
Line type	LT;	Solid line
Line pattern length	LTn,4;	4% of the diagonal distance between P1 and P2
Pen state	PU;	Up
Pen velocity	VS;	38.1 cm/s (15 in./s)
Scaling	SC;	Off (XY coordinates in plotter units)
Input window	IW;	Set to hard-clip limits
Chord angle	—	5 degrees
Symbol mode	SM;	Off
Digitize clear	DC;	Digitize mode off
Tick length	TL;	$t_p = t_n = 0.5\%$ of $(P2x - P1x)$ for Y-tick and 0.5% of $(P2y - P1y)$ for X-tick
Mask value	IM223,0,0;	All errors recognized, no service request, and no parallel poll response
Fill type	FT;	Type 1 (solid bidirectional shading)
Fill spacing	FT;	1% of the diagonal distance between P1 and P2 (used only for fill type 3 or 4)
Fill angle	FT;	0-degree
Pen thickness	PT;	0.3 mm (fill spacing for solid fill types 1 and 2)
Label origin	—	Current pen location
Relative character direction	DR1,0;	Horizontal (along X-axis)
Relative character size	SR;	Width = 0.75% of $(P2x - P1x)$ Height = 1.5% of $(P2y - P1y)$
Character slant	SL0;	0 degree
Label terminator	DT ETX	ETX (ASCII decimal equivalent 3)
Character set selected	SS;	Standard
Standard character set	CS0;	Set 0
Alternate character set	CA0;	Set 0

The Demonstration Plot/Confidence Test

The plotter has a built-in demonstration plot that will run on any size paper. However, the plot is centered only on A-size paper and approximately centered on A4-size paper. Therefore, if the plotter is set for B- or A3-size paper, the plotter will automatically switch to the corresponding smaller paper size before running the plot. After the demonstration plot is completed, all plotter functions, except paper size, are returned to their default conditions and the plotter is ready for normal operation. Although satisfactory execution of the demonstration plot does not exclude all possible failures, it does serve as a confidence test since the probability is very high that the plotter is operating properly. The demonstration plot is performed as follows:

1. Load A- or A4-size paper and a full carousel into the plotter. The carousel may be filled with any combination of pens. However, the pen widths and colors shown in the following table are recommended for drawing the demonstration plot.

Pen Number	Pen Type and Color
1	P.7, black
2	P.3, black
3	P.3, red
4	P.3, green
5	P.3, blue
6	P.3, violet

2. Initiate the demonstration plot shown on the next page by holding down the P1 and P2 pushbuttons at the same time the plotter is turned on. Continue depressing P1 and P2 until the tapping noise begins.

Plotter Operation

GRAPHICS IMPROVES COMMUNICATION

REVENUE DISTRIBUTION

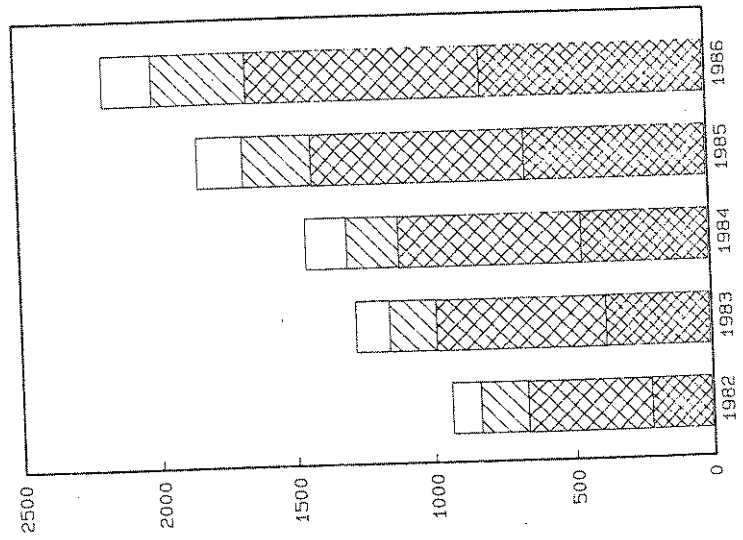
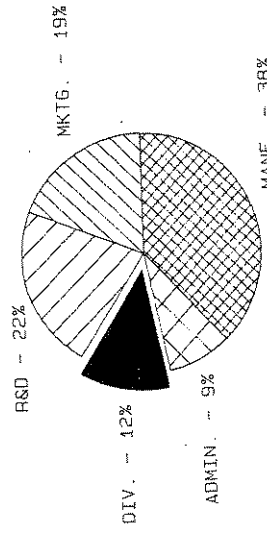

DIVIDEND HISTORY

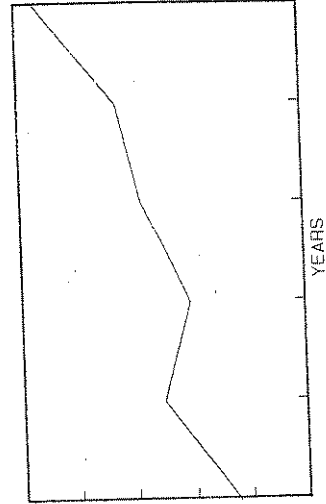

The Demonstration Plot

NOTES

Plotter Operation

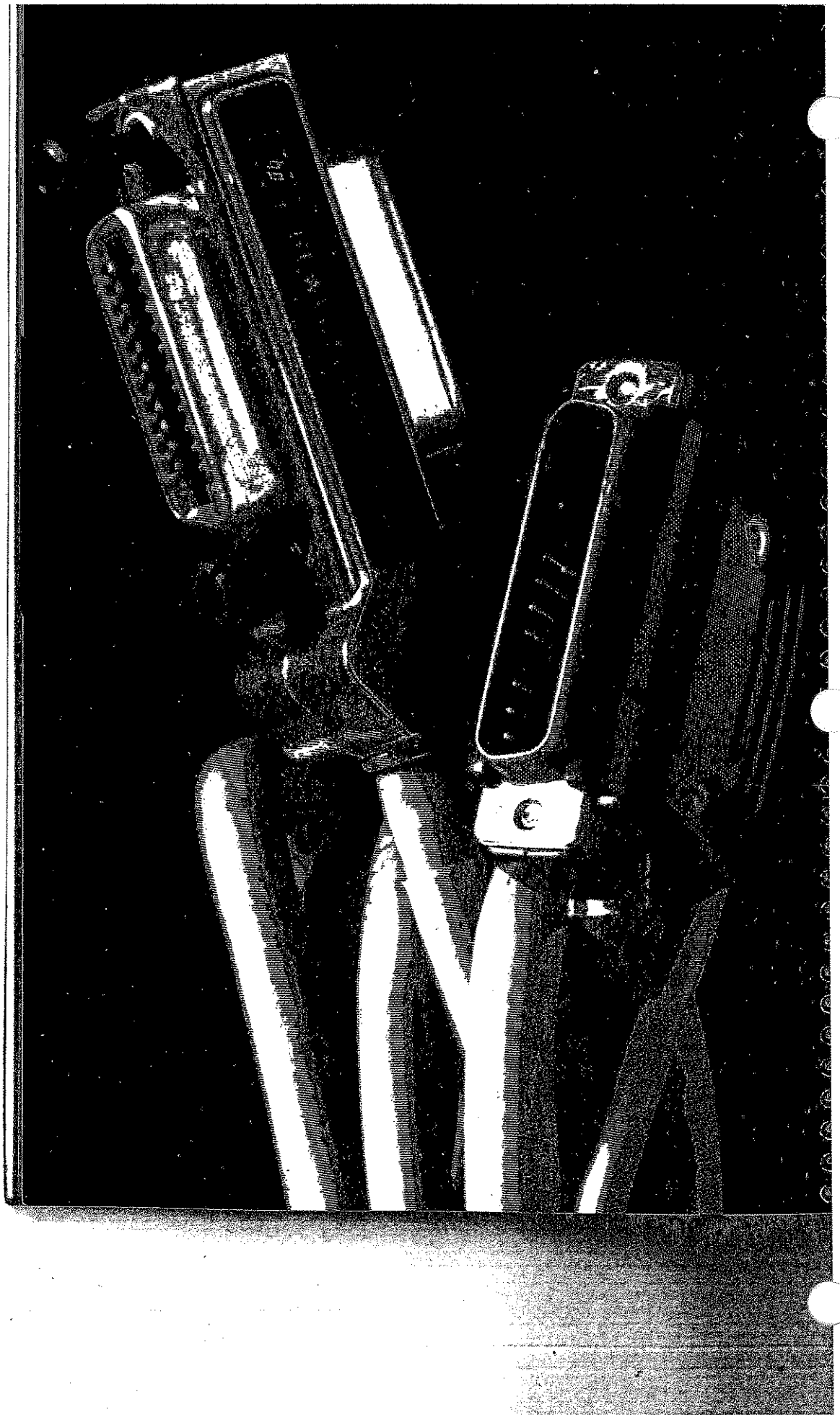

Chapter 3

Plotter Interconnection

Introduction

This interconnection guide is designed to help you connect the HP 7475A Graphics Plotter to your computer and verify communication between them.

Read the general instructions in the following paragraphs, then locate and use the interfacing instructions for the computer you are using.

Each instruction set lists a required minimum system configuration, gives connection instructions for the hardware, and provides a short program to verify that programming information is being sent correctly from the computer to the plotter. Once this has been verified, you can use the Interfacing and Programming Manual to write your own programs (refer to *Accessories Available* in Chapter 1), or you can use a software package already written for your computer/plotter system.

If Your Computer Isn't Listed...

If your computer isn't listed, there is a good possibility that it still can be interfaced to the HP 7475A. First, determine which kinds of communication interfaces are available for your computer. If your computer supports an RS-232-C/CCITT V.24 interface or an ANSI/IEEE 488-1978 (HP-IB) interface, then it probably can be interfaced to an HP 7475A. Read the manual that describes the communications equipment for your computer, and then determine how information is sent and received. Next, refer to either Chapter 9 or 10 in the HP 7475A Interfacing and Programming Manual (depending on which interface you're using) to get a better understanding of how information is sent and received by the plotter. In the RS-232-C environment, pay particular attention to the cabling requirements between the computer and the plotter. (Appendix A contains RS-232-C pin allocations and cable schematics for Hewlett-Packard cables.) Then, choose a computer configuration in this guide that appears similar to yours and use this as a guideline for creating your own communication verification program.

If Your System Configuration Is Different From the One Listed . . .

There are many variables in computer systems. Often substituting one piece of hardware or software for another can cause communication problems. Therefore, if you're going to make substitutions, be aware that these may affect the operation of the system or the communication verification program.

If you are having problems getting your system to work with substitute hardware, carefully read the manual on the substitute equipment. Try to identify the difference between the hardware you are using and that which is recommended. Also consult either Chapter 9 or 10 of the Interfacing and Programming Manual to understand what is required to communicate with the plotter. Again, in the RS-232-C environment, pay particular attention to the cabling requirements between the computer and the plotter. Finally, adapt the interconnection and programming information for use with your hardware configuration.

If you are having problems getting the program to work with substitute software, read the software manual, paying particular attention to the sections dealing with programming the communications hardware. There are usually two parts to this type of program — opening the communications port and writing to the communications port. Opening the communications port may require specifying a number of interface parameters, such as baud rate, parity, etc. For more information on what the plotter requires for communication, see Chapter 9 or 10 of the Interfacing and Programming Manual. Writing to the communications port is usually straightforward. The plotter communicates using ASCII code. Find the output statement in your language that can send an ASCII string to the communications port. Then adapt the communication verification program for use with your operating system and/or programming language.

If the Interconnection Doesn't Work . . .

If you have connected the system as shown, running the verification program should cause the plotter to label "COMMUNICATION OK". If it doesn't, there are a number of things to check:

Is your computer working properly?

- Check the computer by running a program that you know works.

Is your communications hardware and cable working properly?

- Check the interface and cable with another peripheral.
- Check that none of the connectors on the computer interface, cable, or plotter interface are damaged.
- Try another cable if one is available.
- See that the switches are set properly on your communications hardware.
- Make sure the card is in the proper slot in the computer.
- Make sure the output port connected to the plotter is the one specified by the software.

Is your plotter working properly?

- Chapter 2 of this manual describes how to perform the HP 7475A plotter confidence test.
- Make sure the switches on the back of the plotter are set properly.
- Check to see that the plotter is turned on, paper is properly loaded, and the VIEW pushbutton has not been pressed.

Are you using the proper operating system and programming language?

- Check to see if you are using the operating system and/or programming language listed in each instruction set.

If you are still having problems, contact your salesperson. Your salesperson will probably be able to help solve your problem or refer you to someone who can.

If You Are Using a Graphics Software Package...

Some software packages designed to be used with your computer and the HP 7475A may require you to configure your system differently than described in this guide. For example, a software package may require you to use slightly different plotter switch settings. If you are using a graphics software package with your system, always *check the software documentation* to make sure the configuration requirements are being met.

Personal Computers

(Compatibles using RS-232-C Interface)

These instructions tell you how to connect your plotter to the following compatible computers.

AT&T PC 6300
COMPAQ DESKPRO 286 and 386/20
HP Vectra, ES/12, QS/16, and RS/20
IBM AT, PC, PC/XT, and PS/2

Computer	Cable
AT&T PC 6300, COMPAQ 286 and 386, IBM AT, PC, PC/XT, PS/2 with standard serial interface using a 25-pin male connector	HP 17255D
with asynchronous communication adapter using a 9-pin male connector	HP 24542G
HP Vectra, ES/12, QS/16, RS/20 with HP 24540A or HP 24541A card using 9-pin male connector	HP 24542G
with the HP 24541A dual serial card using 25-pin female connector	HP 17255M or HP 13242G

Plotter Interconnection

Interconnection Instructions

1. Turn off your plotter and computer equipment.
2. If necessary, install the serial interface card. (Refer to your computer documentation for details.) If you installed a serial card, go to step 3.

NOTE: If you have more than one serial port installed, you will need to know whether you're connecting the plotter to COM1 or COM2 (most software will not run on COM3). You will need this information for testing communications and for configuring your software. If you are using COM2, be sure to substitute COM2 for COM1 in the instructions. ■

- Set the switches on the rear panel of your plotter as shown in the following illustration. Your plotter checks the switch settings only when you turn it on, so be sure the plotter is turned off before changing the switch settings.

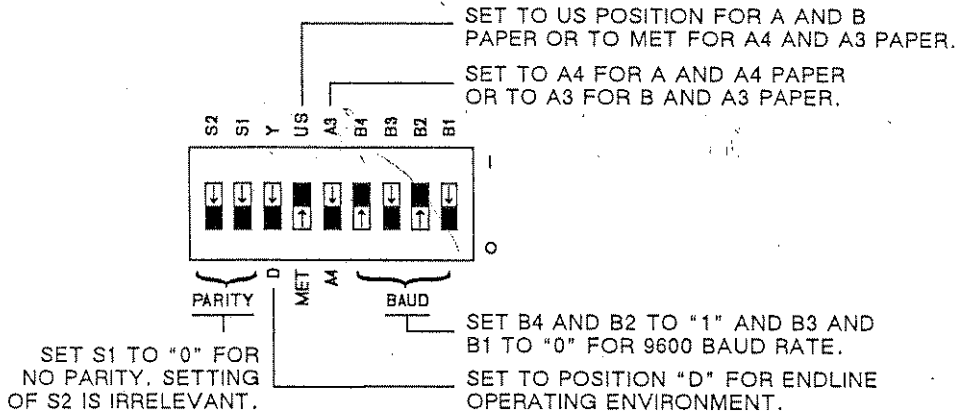

- Connect the plotter to the computer. The following illustration shows an HP Vectra PC. Be sure you are using the correct cable for your computer and plotter.

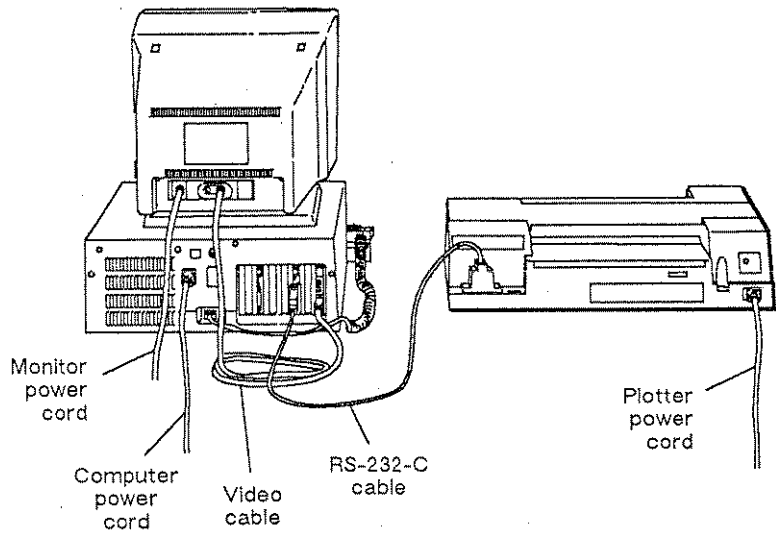

Plotter Interconnection

Testing Communication without BASIC

To test the computer/plotter interface without using BASIC, turn on your computer and plotter, load pens and paper, then follow these steps.

1. At the DOS prompt, type the following (substitute COM2 for COM1, if necessary) and press ENTER.

```
MODE COM1:9600,N,8,1,P
```

This sets the RS-232-C port for 9600 baud, no parity, 8 data bits, one stop bit, and continuous error checking.

2. Type the following (substitute COM2 for COM1, if necessary) and press ENTER.

```
ECHO IN;SP1;PA0,0;PD0,1500,1500,1500,0,0;SP0>COM1
```

The plotter selects pen #1, draws a triangle on the page, and returns the pen to the carousel.

Testing Communication with BASIC

To test the computer/plotter interface, turn on your computer and plotter, load pens and paper, then follow these steps.

1. At the DOS prompt, type the following (substitute COM2 for COM1, if necessary) and press ENTER.

```
MODE COM1:9600,N,8,1,P
```

This sets the RS-232-C port for 9600 baud, no parity, 8 data bits, one stop bit, and continuous error checking.

2. Enter and run the following BASIC program (substitute COM2 for COM1, if necessary). (If you need help entering and running the program, refer to your computer documentation.)

```
10 OPEN "COM1:9600,N,8,1,RS,CS65535,DS,CD" AS #1
20 PRINT #1, "IN:OI;"
30 INPUT #1, ID$
40 PRINT #1, "SP1;PA500,500;"
50 PRINT #1, "LB"+ID$+" PLOTTER OK"+CHR$(3)
60 PRINT #1, "PA0,0;SP0;"
70 END
```

Your plotter selects pen #1 and prints 7475A PLOTTER OK.

Apple IIe or II Plus Computer

(RS-232-C Interface)

Computer	Cable
Apple IIe or II Plus Apple Super Serial Card (Apple Part No. A2B0044)	HP 17355M

Interconnection Instructions

1. Install the Apple Super Serial Card as follows (refer to your computer documentation for details).
 - a. Set the two banks of switches on the serial card as shown here:

	1	2	3	4	5	6	7
SW1	Off	On	Off	On	Off	On	On
SW2	On	Off	Off	On	Off	Off	Off

- b. With your computer unplugged, install the serial card in slot #2 of the computer. Make sure that the arrow on the card's jumper block is pointing toward the word "TERMINAL."

Plotter Interconnection

- With your plotter and computer turned off, connect the plotter to the computer using the RS-232-C cable as shown below. Either end of the cable can be connected to the plotter or the connector on the installed serial card (port #2). The following illustration shows an Apple IIe.

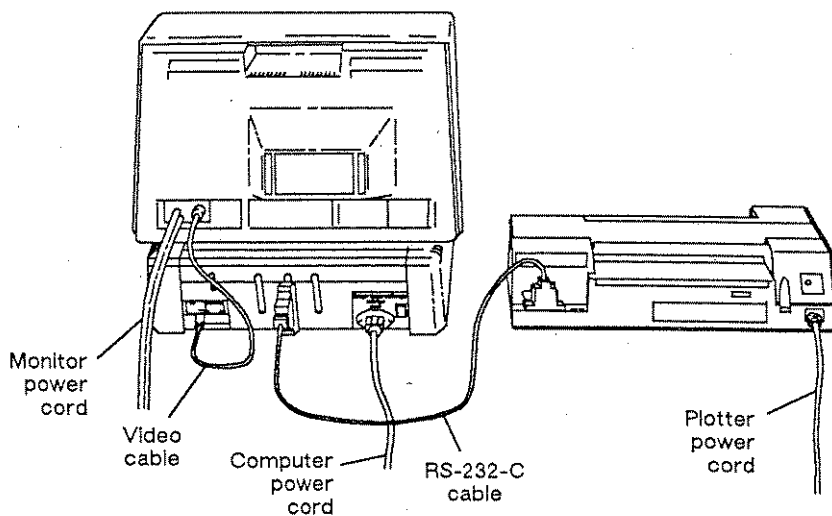

- Set the switches on the rear panel of your plotter as shown in the following diagram. Your plotter checks the switch settings only when you turn it on, so be sure the plotter is turned off before changing switch settings. (You are not limited to a 2400 baud rate, but the plotter's baud rate and the baud rate on your serial card must match.)

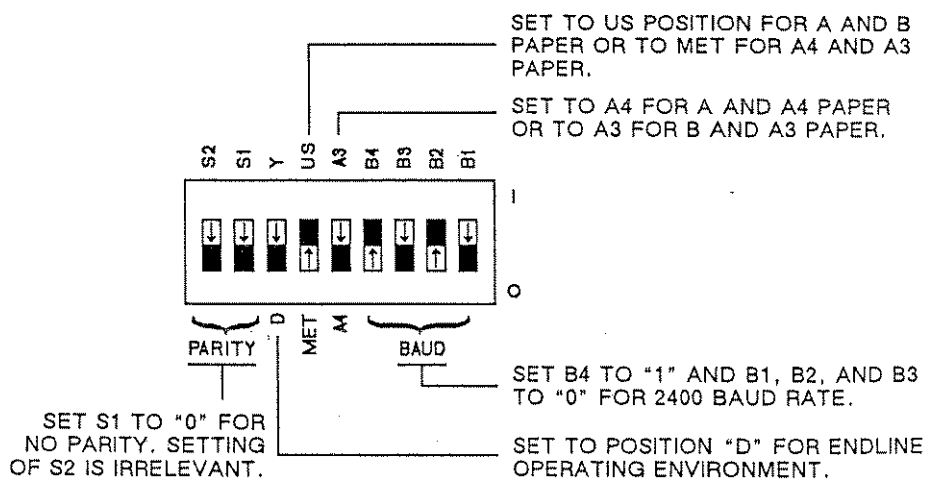

Running the Test Program

To test the computer/plotter interface, turn on your computer and plotter, load pens and paper, and enter and run the following BASIC program. (If you need help entering and running the program, refer to your computer documentation.)

```
10 PR#2 : IN#2
20 PRINT CHR$(27) + ".M50;63;13;13:"
30 PRINT "IN;OI;"
40 INPUT ID$
50 PRINT "SP1;PA500,500;"
60 PRINT "LB";ID$;" COMMUNICATION OK";CHR$(3)
70 PRINT "PA0,0;SP0;"
80 PR#0 : IN#0
90 END
```

Your plotter will select pen #1 and print 7475A COMMUNICATION OK.

Apple IIe or II Plus Computer (HP-IB Interface)

Computer	Cable
Apple IIe or II Plus Apple IEEE-488 Card	HP 10833A, B, C, or D

Interconnection Instructions

1. Install the Apple IEEE-488 Card into Slot #3 (refer to your computer documentation for details).
2. With your plotter and computer turned off, connect the plotter to the computer using the HP-IB cable as shown below. The following illustration shows an Apple IIe.

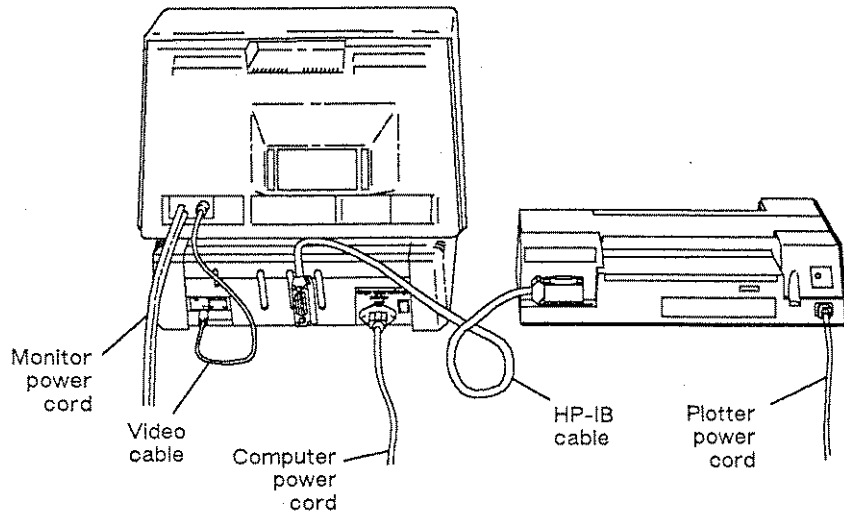

Plotter Interconnection

3. Set the HP-IB switches on the rear panel of your plotter as shown in the following diagram. Your plotter checks the switch settings only when you turn it on, so be sure the plotter is turned off before changing switch settings.

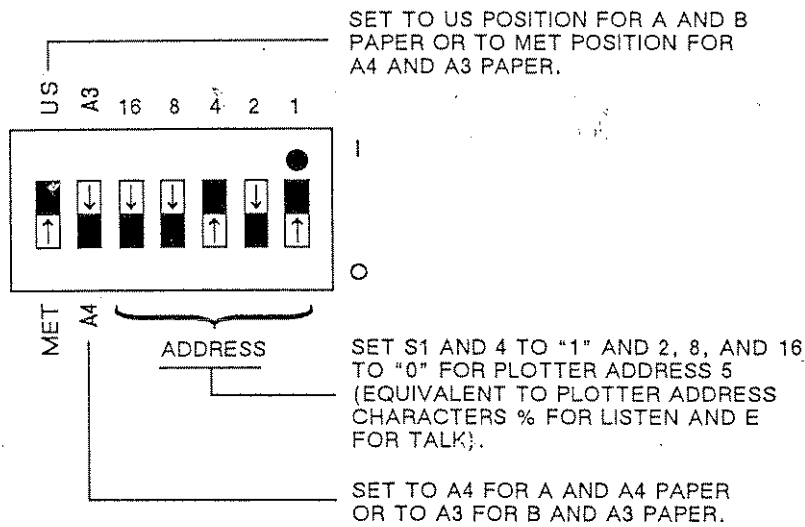

Running the Test Program

To test the computer/plotter interface, turn on your computer and plotter, load pens and paper, and enter and run the following BASIC program. (If you need help entering and running the program, refer to your computer documentation.)

```

10 PR# 3: IN# 3
20 PRINT "WTX"+CHR$(26);
30 PRINT "IN;SP1;PA500,500;";
40 PRINT "LBCOMMUNICATION OK"+CHR$(3);
50 PRINT "PRO,0;SPO;";
60 PRINT CHR$(13);
70 PR# 0: IN# 0
80 END

```

Your plotter will select pen #1 and print 7475A COMMUNICATION OK.

Plotter Interconnection

Apple III Computer (RS-232-C Interface)

Computer	Cable
Apple III Unit	Apple III Modem Eliminator Cable (Apple Part No. A3M0019) and HP 17355M

Interconnection Instructions

1. With your plotter and computer turned off, connect the plotter to the computer using the RS-232-C and modem eliminator cables as shown below. Either end of the RS-232-C cable can be connected to the plotter.

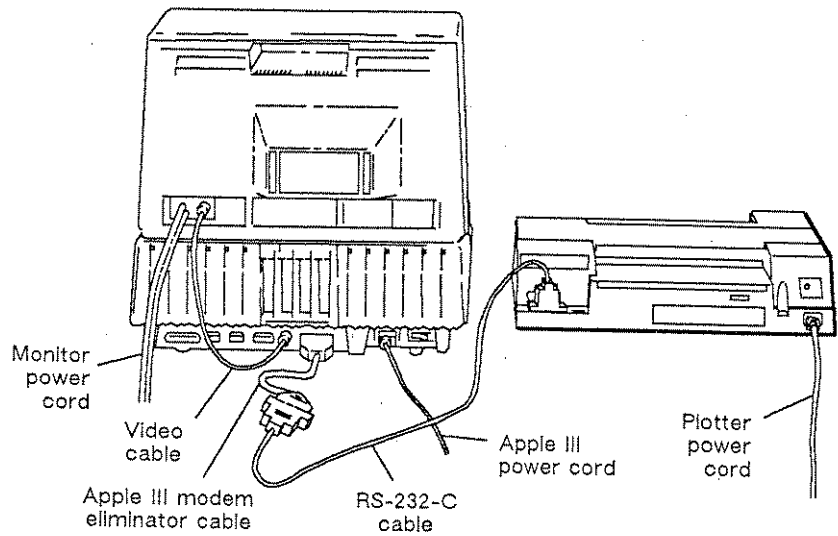

Plotter Interconnection

2. Set the switches on the rear panel of your plotter as shown in the following diagram. Your plotter checks the switch settings only when you turn it on, so be sure the plotter is turned off before changing switch settings.

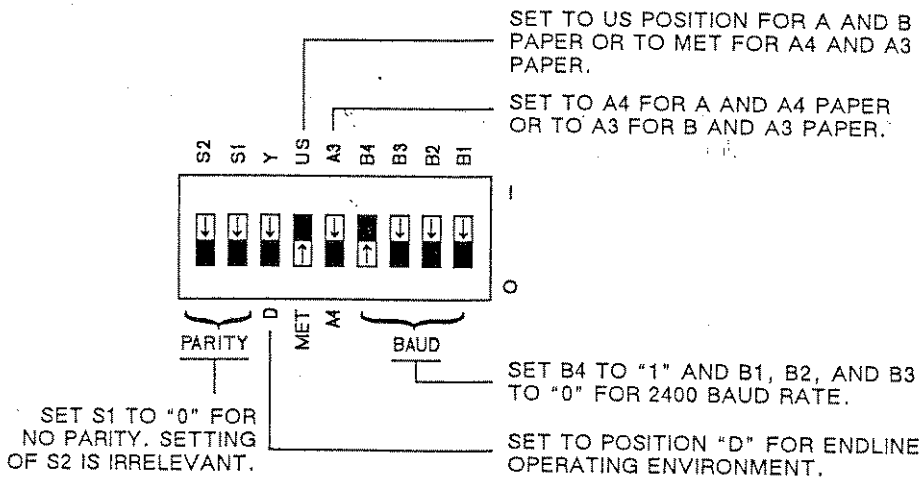

3. Configure your computer system as follows. (Refer to your Apple III Standard Device Drivers Manual if you have difficulty with this step.) In order to run the test program, you will need to make a copy of your Apple Business BASIC disc that is not write protected.
 - a. Insert the System Utilities disc. Select the SYSTEM CONFIG. PROGRAM, then select READ A DRIVER FILE.
 - b. Load the System Utilities Data disc. Enter the pathname .D1/RS232.DRIVER and press the RETURN key. Reinsert the System Utilities disc, and press the ESCAPE key.
 - c. Select EDIT DRIVER PARAMETERS. Then select the number corresponding to .RS232 and press the RETURN key.
 - d. Select CONFIG BLOCK DATA, then enter the following values to set the driver to 2400 baud, 7 data bits, space for parity, and hardwire handshaking.

Byte	0	1	2	3	4	5	6	7	8	9	A	B
Value	0A	2E	00	00	00	00	00	00	00	00	00	80

Press ESCAPE three times to return to the System Configuration Menu. Select READ A DRIVER FILE and read the other driver files by specifying the pathname .D1/SOS.DRIVER. Press ESCAPE to return to System Configuration Menu. Then select GENERATE NEW SYSTEM.

- e. Load the copy of the Apple Business BASIC disc and enter .D1/SOS.DRIVER as the new driver filename. This loads the new system configuration on the BASIC disc. Select DELETE to delete any old system configuration.

Running the Test Program

To test the computer/plotter interface, turn on your computer and plotter, load pens and paper, and enter and run the following BASIC program. (If you need help entering and running the program, refer to your computer documentation.)

```
10 OPEN "0",1,"PLT"  
20 PRINT #1,"IN;SP1;PA500,500;"  
30 PRINT #1,"LBCOMMUNICATION OK"+CHR$(3)  
40 PRINT #1,"PRO,0;SPO;"  
50 END
```

Your plotter will select pen #1 and print 7475A COMMUNICATION OK.

Apple Macintosh/Macintosh Plus/II/SE (RS-232-C Interface)

Computer	Cable
Apple Macintosh Computer	HP 92219M
Apple Macintosh Plus	HP 17302A
Apple Macintosh II	HP 17302A
Apple Macintosh SE	HP 17302A

Interconnection Instructions

1. Turn off your plotter and computer equipment.
2. Set the switches on the rear panel of your plotter as shown in the following illustration. Your plotter checks the switch settings only when you turn it on, so be sure the plotter is turned off before changing the switch settings.

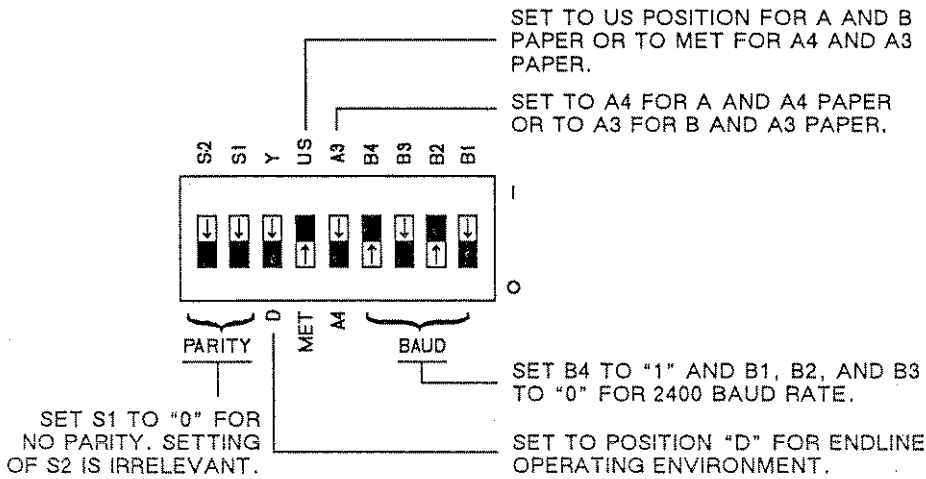

Plotter Interconnection

3. Connect the plotter to the computer. The following illustration shows an Apple Macintosh Computer. Be sure you use the correct cable for your computer.

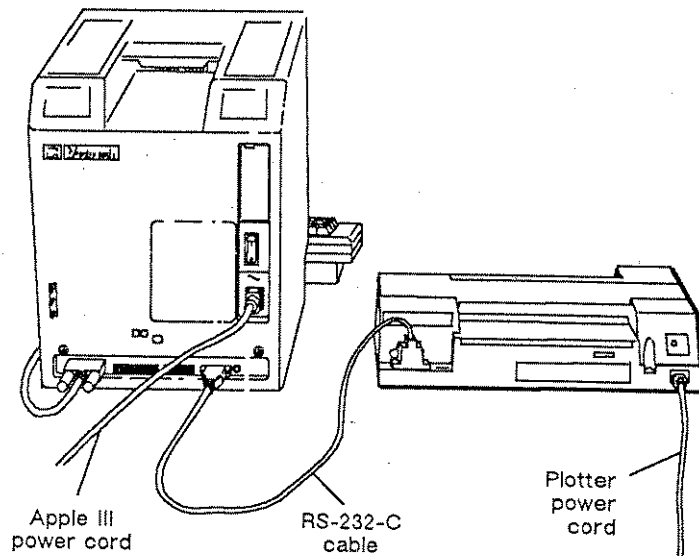

Testing Communication with BASIC

To test the computer/plotter interface, turn on your computer and plotter, load pens and paper, then enter and run the following BASIC (Macintosh BASIC 2.0 or higher) program. (If you need help entering and running the program, refer to your computer documentation.)

```
10 OPEN "COM1:9600,N,8,1,RS,CS65535,DS,CD" AS #1
20 PRINT #1, "IN;DI;"
30 INPUT #1, ID$
40 PRINT #1, "SP1;PA500,500;"
50 PRINT #1, "LB"+ID$+" PLOTTER OK"+CHR$(3)
60 PRINT #1, "PA0,0;SP0"
70 END
```

Your plotter selects pen #1 and prints 7475A PLOTTER OK.

NOTE: If you are not using BASIC, a plotter driver is required to run a Macintosh computer with the plotter. Check with your computer or plotter dealer for available drivers. (Some packages may require the baud rate or configuration to be altered. Consult the software package manual before proceeding.) ■

Commodore Amiga Personal Computers (Serial Interface)

Computer	Cable
Amiga 500	HP 17255D
Amiga 1000	HP 17255M (or 13242G)
Amiga 2000	HP 17255D

Interconnection Instructions

1. With your equipment turned off, use the cable to connect the plotter to the computer's serial port. (The following illustration shows an Amiga 2000.)

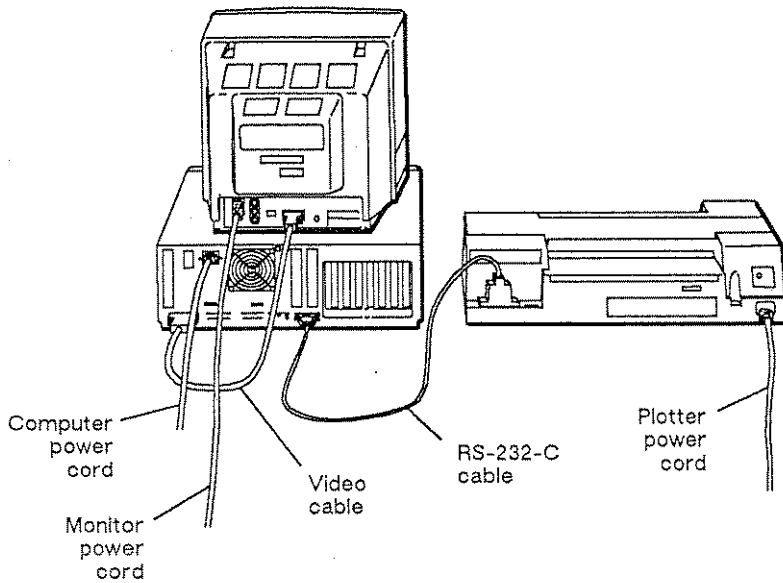

Plotter Interconnection

- Set the switches on the rear panel of your plotter as shown in the following diagram. Your plotter checks the switch settings only when you turn it on, so be sure the plotter is turned off before changing the switch settings.

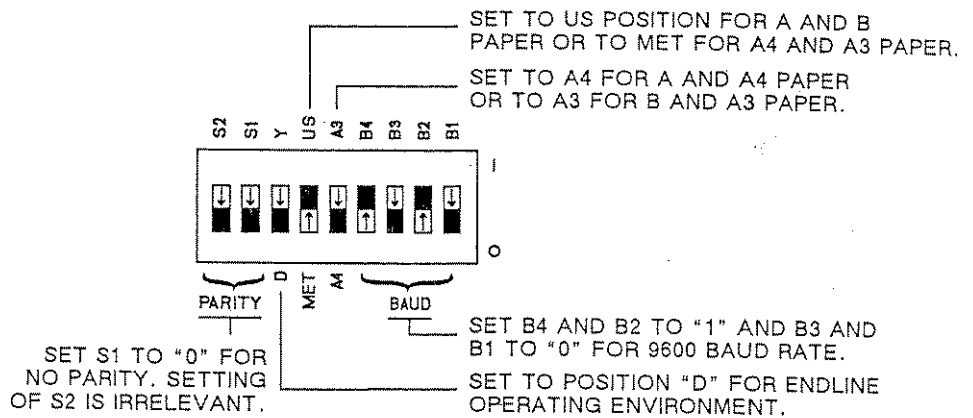

- Turn on the plotter and boot up the Amiga using your working copy of the Workbench operation system.
- Run the Printer utility in the Workbench Preferences drawer (refer to Commodore's Workbench documentation).
- From the Printer main menu, select the **Serial** interface.
- Save your settings and return to the Preferences drawer.
- Set the Amiga's serial port settings as follows (refer to Commodore's Workbench documentation).
 - Double click on the *Serial* icon in the Preferences drawer.
 - Select the following settings.

Baud Rate:	9600
Read Bits:	8
Stop Bits:	1
Handshaking:	RTS/CTS
Buffer Size:	512 (may be adjusted as needed)
Write Bits:	8
Parity:	None
 - Save your settings and return to the Workbench.

Verifying Communication

1. From Workbench, open the Utilities drawer. Start the Notepad application by double-clicking on the *Notepad* icon.
2. Type the following HP-GL commands (uppercase only) into Notepad.

```
IN;SP1;SP2;SP0;
```

3. Select **Print as Draft**, then **Print** to send the commands to the plotter.

The plotter should select pen #1 and pen #2 sequentially.

HP Series 200 Personal Technical Computer (HP-IB Interface)

Computer	Cable
HP Model 216, 226, or 236 Computer	HP 10833A, B, C, or D

Interconnection Instructions

1. With your plotter and computer turned off, connect the plotter to the computer using the HP-IB cable shown. Either end of the cable can be connected to the plotter or computer. The illustration below shows an HP Model 216 connected to the plotter.

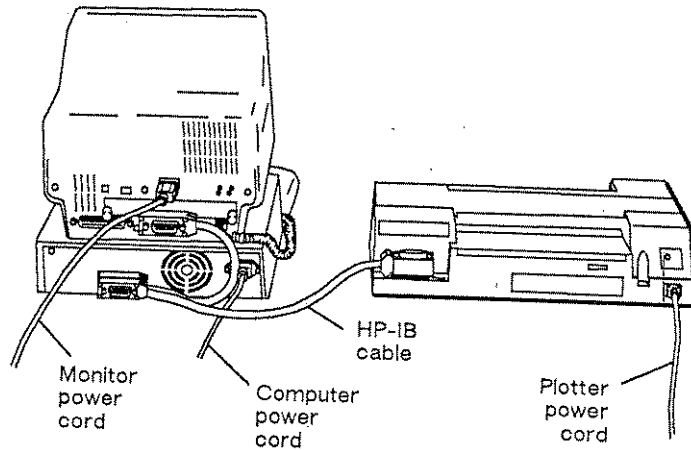

Plotter Interconnection

- Set the switches on the rear panel of your plotter as shown in the following diagram. Your plotter checks the switch settings only when you turn it on, so be sure the plotter is turned off before changing switch settings.

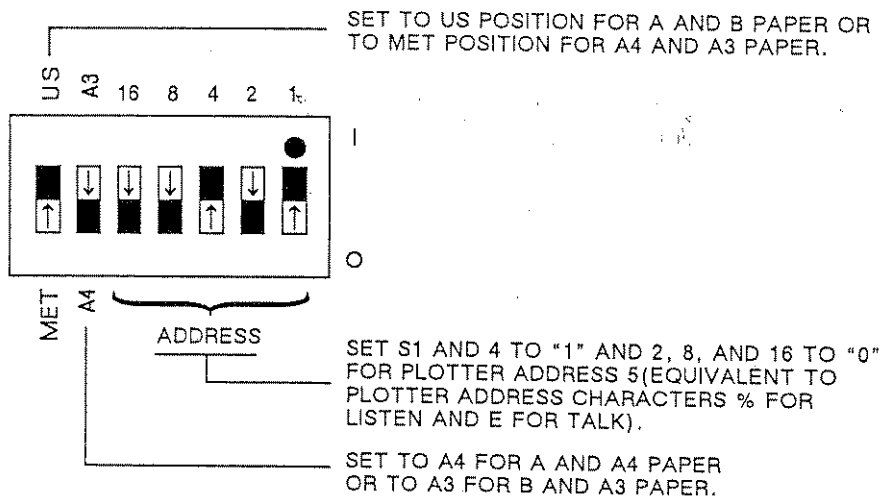

Running the Test Program

To test the computer/plotter interface, turn on your computer and plotter, load pens and paper, and enter and run the following BASIC program. (If you need help entering and running the program, refer to your computer documentation.)

```

10 OUTPUT 705 ; "IN;OI;"
20 ENTER 705 ; ID$
30 OUTPUT 705 ; "SP1;PA500,500;"
40 OUTPUT 705 ; "LB"&ID$&" COMMUNICATION OK"&CHR$(3)
50 OUTPUT 705 ; "PA0,0;SP0;"
60 END

```

Your plotter will select pen #1 and print 7475A COMMUNICATION OK.

HP Touchscreen Personal Computer (HP 150) (RS-232-C Interface)

Computer	Cable
HP Touchscreen or Touchscreen MAX Personal Computer (or HP 150 System with Dual Disc Drive)	HP 17255M or HP 13242G

Interconnection Instructions

1. With your plotter and computer turned off, connect the plotter to port 2 of the computer using the RS-232-C cable as shown below. Either end of the cable can be connected to the plotter or computer.

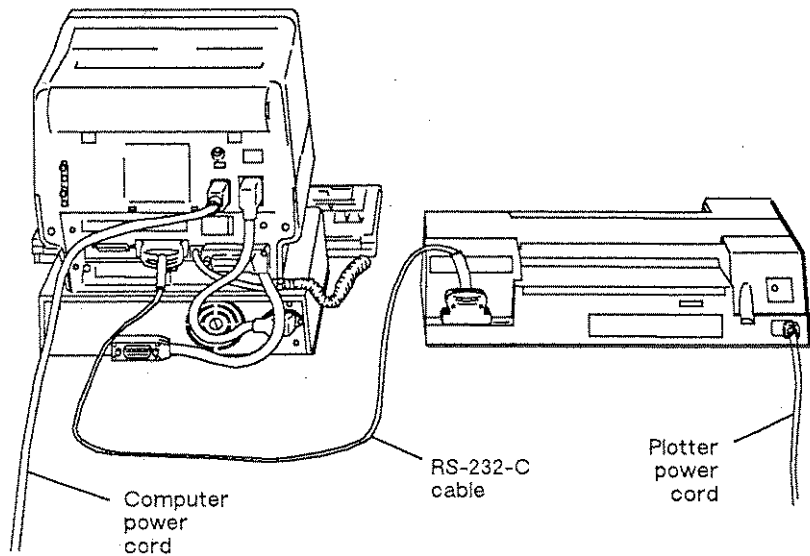

Plotter Interconnection

2. Set the switches on the rear panel of your plotter as shown in the following diagram. Your plotter checks the switch settings only when you turn it on, so be sure the plotter is turned off before changing switch settings.

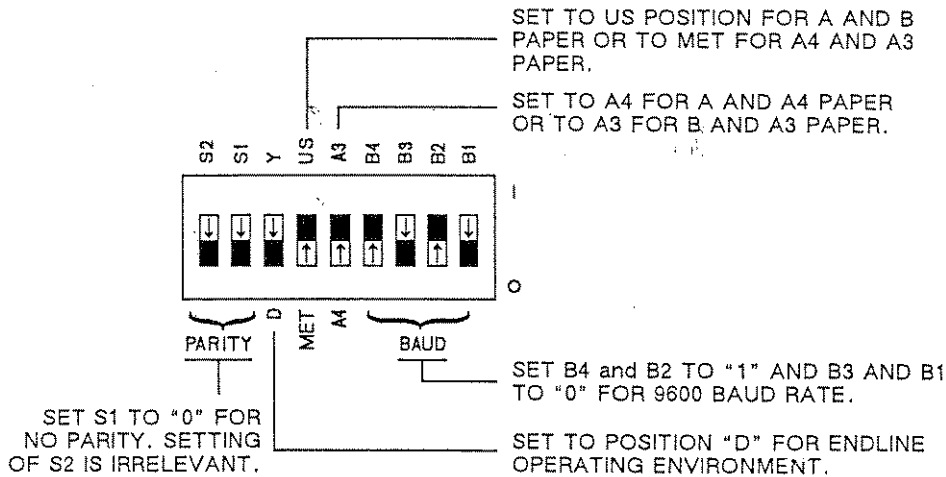

3. Configure your computer system as follows. (Refer to your computer documentation if you have difficulty with this step.)
 - a. Load the MS-DOS System Disc. Touch DEVICE CONFIG. Then touch START APPLIC to display the DEVICE CONFIGURATION screen.
 - b. Touch the PLT field, then use the NEXT CHOICE key to select PLT: PORT 2. Next, touch SAVE CONFIG.
 - c. Press the USER/SYSTEM key on your keyboard twice to change the function key selections. Then select CONFIG KEYS.
 - d. Select the PORT 2 CONFIG field to display the PORT 2 screen. Press the SYSTEM DEFAULTS key, then the DEFAULT VALUES key. Use the NEXT CHOICE key to select BAUD RATE 9600. Then use the cursor controls to select the CS(CB)XMIT field. Use the NEXT CHOICE key to set the field to YES.
 - e. Touch SAVE CONFIG to save the new configuration. Hold down the SHIFT key and press the USER/SYSTEM key. Press the EXIT CONFIG to return to P.A.M.

Plotter Interconnection

Running the Test Program

To test the computer/plotter interface, turn on your computer and plotter, load pens and paper, and enter and run the following BASIC program. (If you need help entering and running the program, refer to your computer documentation.)

```
10 OPEN "O",1,"PLT"  
20 PRINT #1, "IN;OI;"  
30 CLOSE #1  
40 OPEN "I",2,"PLT"  
50 INPUT #2, ID$  
60 OPEN "O",1,"PLT"  
70 PRINT #1, "SP1;PA500,500;"  
80 PRINT #1, "LB";ID$;" COMMUNICATION OK"+CHR$(3)  
90 PRINT #1, "PA0,0;SP0;"  
100 END
```

Your plotter will select pen #1 and print 7475A COMMUNICATION OK.

HP Touchscreen Personal Computer (HP 150) (HP-IB Interface)

Computer	Cable
HP Touchscreen or Touchscreen MAX Personal Computer (or HP 150 System with Dual Disc Drive)	HP 10833A, B, C, or D

Interconnection Instructions

1. With your plotter and computer turned off, connect the plotter to port 2 of the computer using the HP-IB cable as shown below. Either end of the cable can be connected to the plotter or computer.

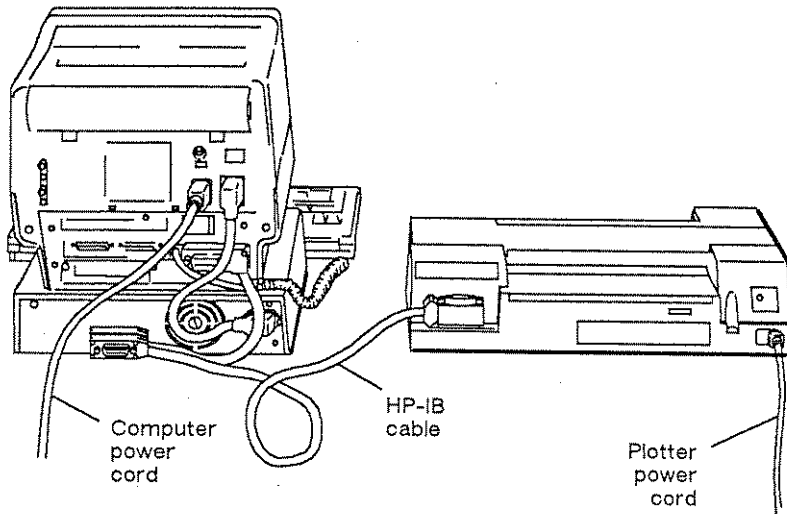

Plotter Interconnection

2. Set the switches on the rear panel of your plotter as shown in the following diagram. Your plotter checks the switch settings only when you turn it on, so be sure the plotter is turned off before changing switch settings.

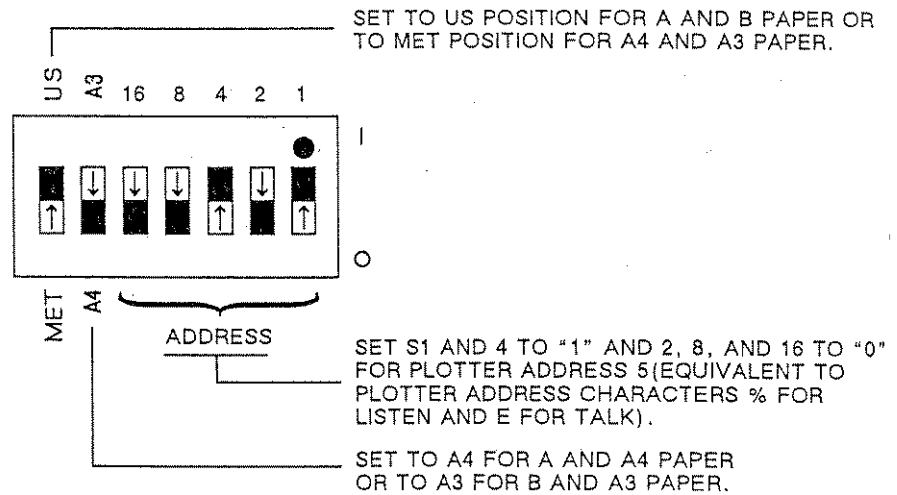

3. Configure your computer system as follows. (Refer to your computer documentation if you have difficulty with this step.)
 - a. Load the MS-DOS System Disc. Touch DEVICE CONFIG. Then touch START APPLIC to display the device configuration screen.
 - b. Touch the PLT field, then use the NEXT CHOICE key to select PLT: HP-IB 5. Touch SAVE CONFIG to save the configuration.
 - c. Press EXIT CONFIG key to return to P.A.M.

Running the Test Program

To test the computer/plotter interface, turn on your computer and plotter, load pens and paper, and enter and run the following BASIC program. (If you need help entering and running the program, refer to your computer documentation.)

Your plotter will select pen #1 and print COMMUNICATION OK.

Set the plotter switches on the back panel as shown by the following diagram.

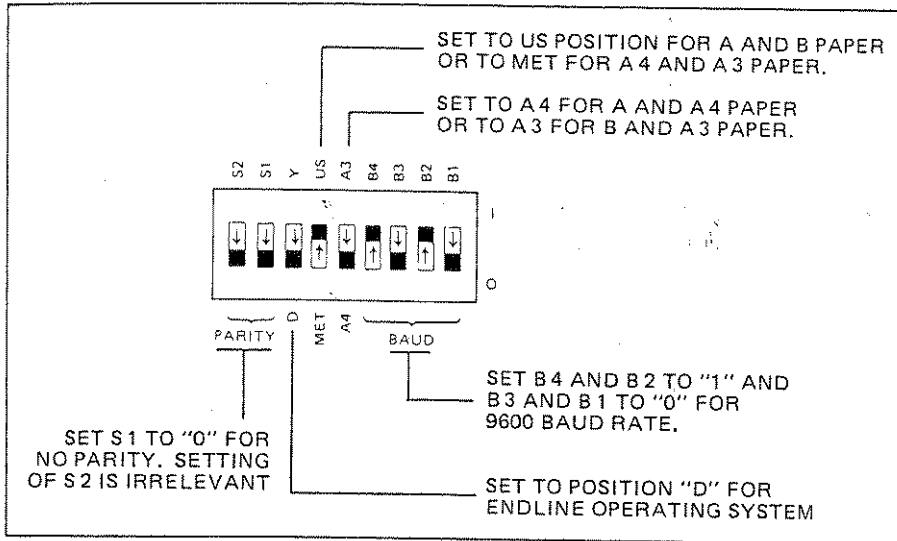

Set the DEC 100's printer port configuration as follows: Press the "Set-Up" key, then press the "Next Screen" key three times to display the Printer set-up. Use the arrow keys to change the screen to read "8N=DATA B/P" and "9600=XMIT/RCV BAUD".

Communication Verification

Load pens and paper and run the following MBASIC program:

```

10 LPRINT "IN;"
20 LPRINT CHR$(27)+".I80;0;17:"
30 LPRINT CHR$(27)+".N0;19:"
40 LPRINT "SP1;PA500,500;"
50 LPRINT "LBCOMMUNICATION OK"+CHR$(3)
60 LPRINT "PA0,0;SPO;"
70 END

```

Plotter labels: COMMUNICATION OK

Plotter Interconnection

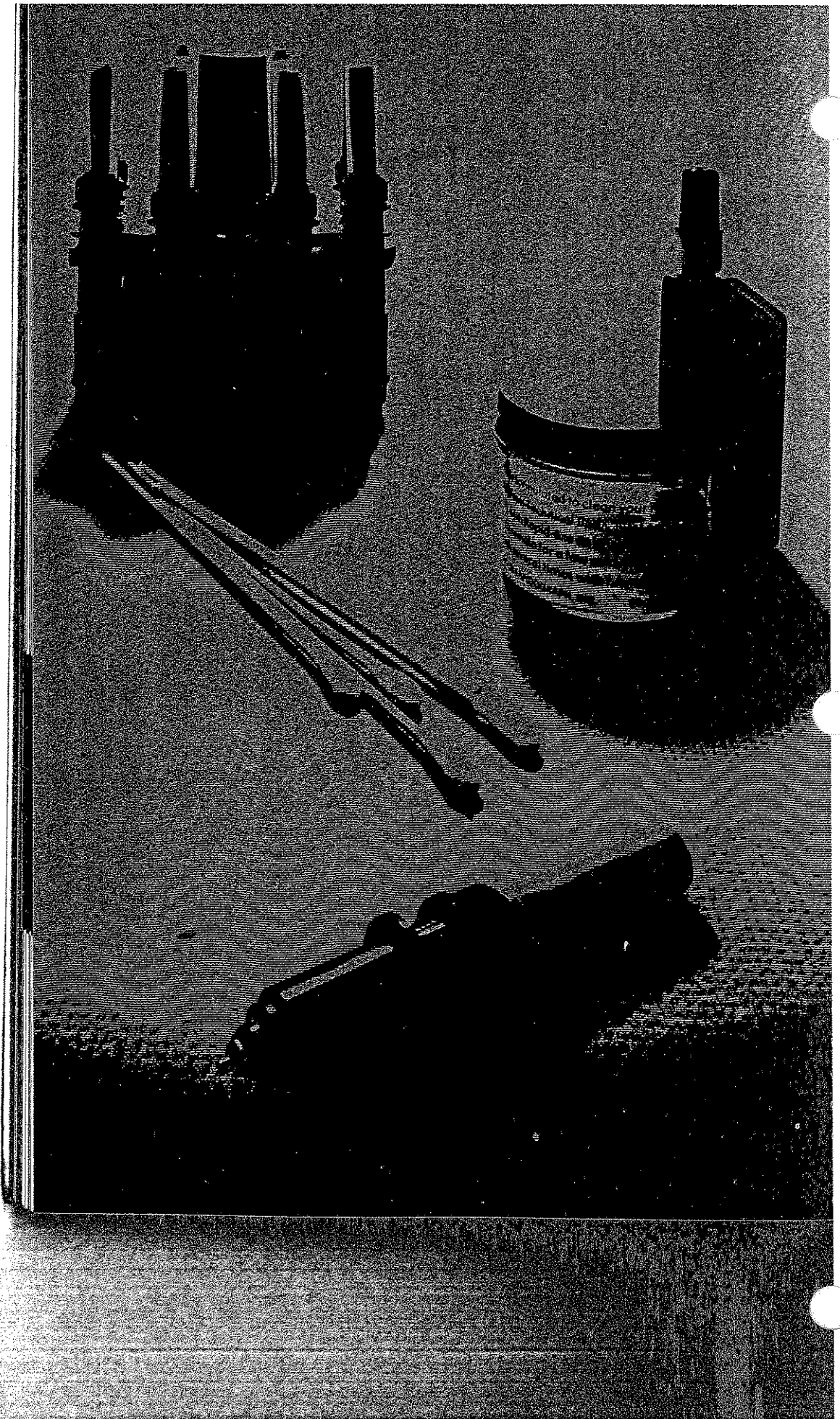

Chapter 4

Selecting Pens and Media

Introduction

This chapter describes the pens and media that can be used with your plotter, and how to combine them for best results.

For the highest quality plots, use only Hewlett-Packard supplies. Hewlett-Packard pens and media work together for optimal pen life, plot quality, and plotter performance. The chemical reaction between the pens and media is tested to ensure that fading and color changes are minimized. The smoothness of HP paper reduces abrasion on pen tips and produces a sharp, crisp ink line.

The *Supplies and Cables* brochure, shipped with your plotter, gives part numbers and ordering information for Hewlett-Packard pens and media.

Pens

Your plotter can use fiber-tip paper pens, transparency pens, and short-body refillable drafting pens. Fiber-tip paper and transparency pens are available in vivid, matching colors for duplicating paper and overhead graphics. The following table describes each pen type.

Pen Type	Characteristics
Fiber-tip paper	Easy to use, economic. Even ink flow produces high-quality characters and opaque lines. Disposable.
Fiber-tip transparency	Easy to use, economic. Extra dye produces strong colors for overhead projection. Water-based. Disposable.
Short-body drafting	Produces highest-quality lines. Long lasting, tungsten carbide points. Requires refilling and maintenance.

Fiber-tip pens will last at least 30 days stored in the carousel. However, if you do not plan to plot for several days, remove the pens from the carousel and cap them to ensure a longer pen life.

Remove drafting pens and cap them immediately after use to prevent drying and clogging. Drafting pens require cleaning after each use. Remember that ink dries as quickly in the drafting pen as it does on the plotting media. Here are the maximum times that ink can remain in a drafting pen in an average environment.

- 20 seconds if the pen is uncapped and not in use.
- One day if the pen is in a drafting pen carousel.
- One week if the pen is properly capped and stored in a horizontal position.

Symptoms and Solutions

Drafting pens provide the highest quality lines available on the plotter. If you are not getting the quality of output you desire, consult the following table. It will help you diagnose and correct output problems.

Symptoms and Solutions

Problem	Possible Cause	Solution
Pen does not write.	Pen is clogged. Cleaning wire is bent.	Clean the pen. Replace the point.
Beginning of a line does not show.	Ink is starting to dry in the tip.	Before plotting, draw lines by hand, dip tip in water, or use a syringe.
Pen skips or drags.	Pen is partially blocked. There is oil on the medium.	Clean the pen and the boot. Replace the sheet, keep hands clean, handle sheets along the edges.
Pen tip clogs frequently.	Tip is worn out. Point is too fine.	Replace the tip. Do not use 0.18 mm and 0.25 mm points.

Symptoms and Solutions (Continued)

Problem	Possible Cause	Solution
	There is static buildup on the medium.	Reduce pen speed, increase humidity, use static-resistant film or another medium.
Ink leaks between the point and adaptor.	Internal airflow is obstructed or vent is clogged.	Clean the pen.
Pen tips wear out rapidly.	Film surface is abrasive.	Use HP film.
Lines look wavy.	Pen tip is damaged. Plotter may need adjustment.	If the tip is not centered, replace it. If wavy lines are not caused by a damaged pen, contact an HP service representative.
Line width is not uniform.	Pen is dirty. Ink flow is insufficient.	Clean the pen. Reduce pen speed or use thinner ink.
Ink flow is uneven.	Pen is dirty. Pen speed is too fast. Pen is running out of ink. Ink is too thick for the pen point.	Clean the pen. Reduce pen speed. Refill the reservoir before it is empty. Use a wider point or dilute the ink with distilled water.
Ink smears or doesn't dry.	Ink and medium are incompatible.	Change the ink or the medium.

Symptoms and Solutions (Continued)

Problem	Possible Cause	Solution
Ink fades or separates.	The ink is old.	Use a new bottle of ink.
Boot is deteriorating.	Ink was diluted with acetone.	Replace the boot. Dilute ink with distilled water, not acetone.

Media

You can use non-glossy plotter paper, glossy plotter paper, transparency plotter film, and double-matte polyester film with your plotter. The following table describes each of these plotting media.

Media Type	Characteristics
Non-glossy plotter paper	Smooth surface, clear line definition. Easy to handle, good for everyday use. Inexpensive.
Glossy plotter paper	Gloss finish, heavy weight. Good for reports and handouts. Regular use requires frequent grit wheel cleaning to prevent residue build up.
Transparency plotter film	High-grade, clear. Good for presentations. Paper backing protects film during plotting.
Double-matte polyester film*	Finely coated and translucent. Good for high-accuracy applications and archive storage. Dimensionally stable. Expensive.

*Film of standard thickness, 3-mil, is recommended for best results.

Handle your plotting media by the edges when preparing final plots. Oil from fingerprints can prevent ink from adhering to the medium.

Plotting media, particularly paper, can be affected by changes in temperature and humidity. Plotting distortions will occur if the medium shrinks or stretches. Stabilize your media by removing a sheet from the package and exposing it to air near the plotter for at least 15 minutes before using it. (This is not necessary for media from an open package that has been exposed to the plotter's environment for several days.)

Media with rounded corners are not recommended for use with your plotter. Square corners are necessary for the pinch wheels to grip and move the media accurately.

Combining Pens and Media

Use the following table to select the types of pens and media that work best together and fit your application. The recommended plotting speed (in centimetres per second) is listed for each combination.

	Fiber-tip Paper Pens	Fiber-tip Transparency Pens	Drafting Pens
Non-Glossy Plotter Paper	High quality for business graphics charts and quick check plots. 38 cm/s	Not recommended.	Not recommended.
Glossy Plotter Paper	Excellent quality for presentations, reports, and handouts. Vivid, professional results. 10 cm/s	Good quality. 10 cm/s	Not recommended.
Transparency Plotter Film	Not recommended.	Excellent quality for overhead presentations and overlays. 10 cm/s	Not recommended.
Double-matte Polyester Film	Not recommended.	Not recommended.	Excellent quality. Sharp, uniform lines. Good contrast for reproductions. 15 cm/s

NOTES

